



**Inter Play**  
AMAZING PLAYGROUNDS

**2026**





# Inter Play

AMAZING PLAYGROUNDS

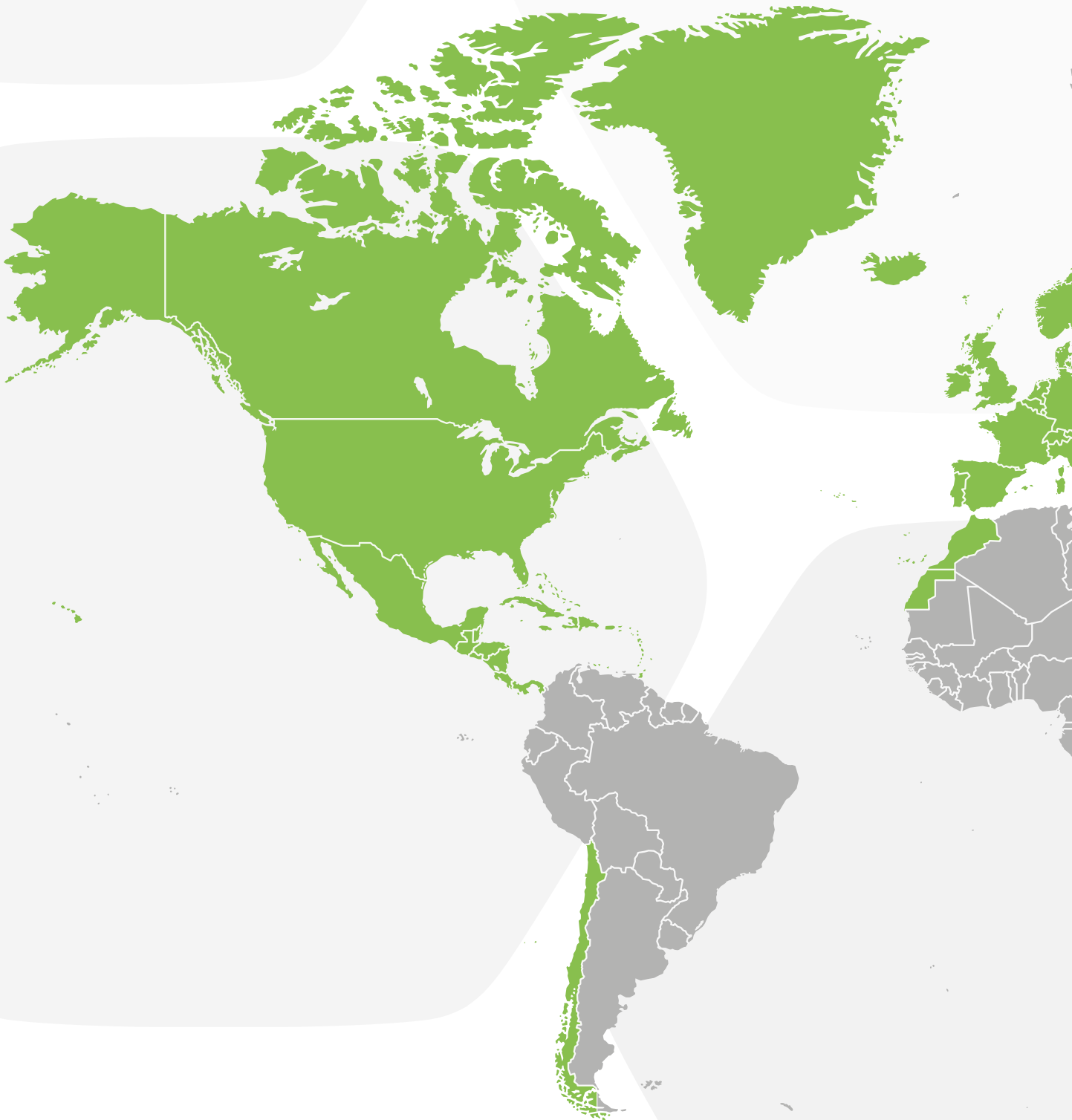



**Playgrounds**  
Spielplätze

SFERO	10
LIMAKO	18
LUMO PLAY	40
SALTO	56
INTEGRADO	78
LINARIUM	108
TRANSPORTO	118
MONTO	122
ROTO	130
PARK	146
AKRA	158
ROBINIA	166
DOG AGILITY	174



**Sport equipment**  
Sportgeräte

SPEED	180
FITNESS	182
STREET WORKOUT	194
NINJA PARK	210
ARENAS	212
OUTDOOR GAMES	218



**Urban furniture**  
Stadtmöbiliar

COLLECTIONS	224
BENCHES	232
TRASH BINS	234
BICYCLE RACKS	235

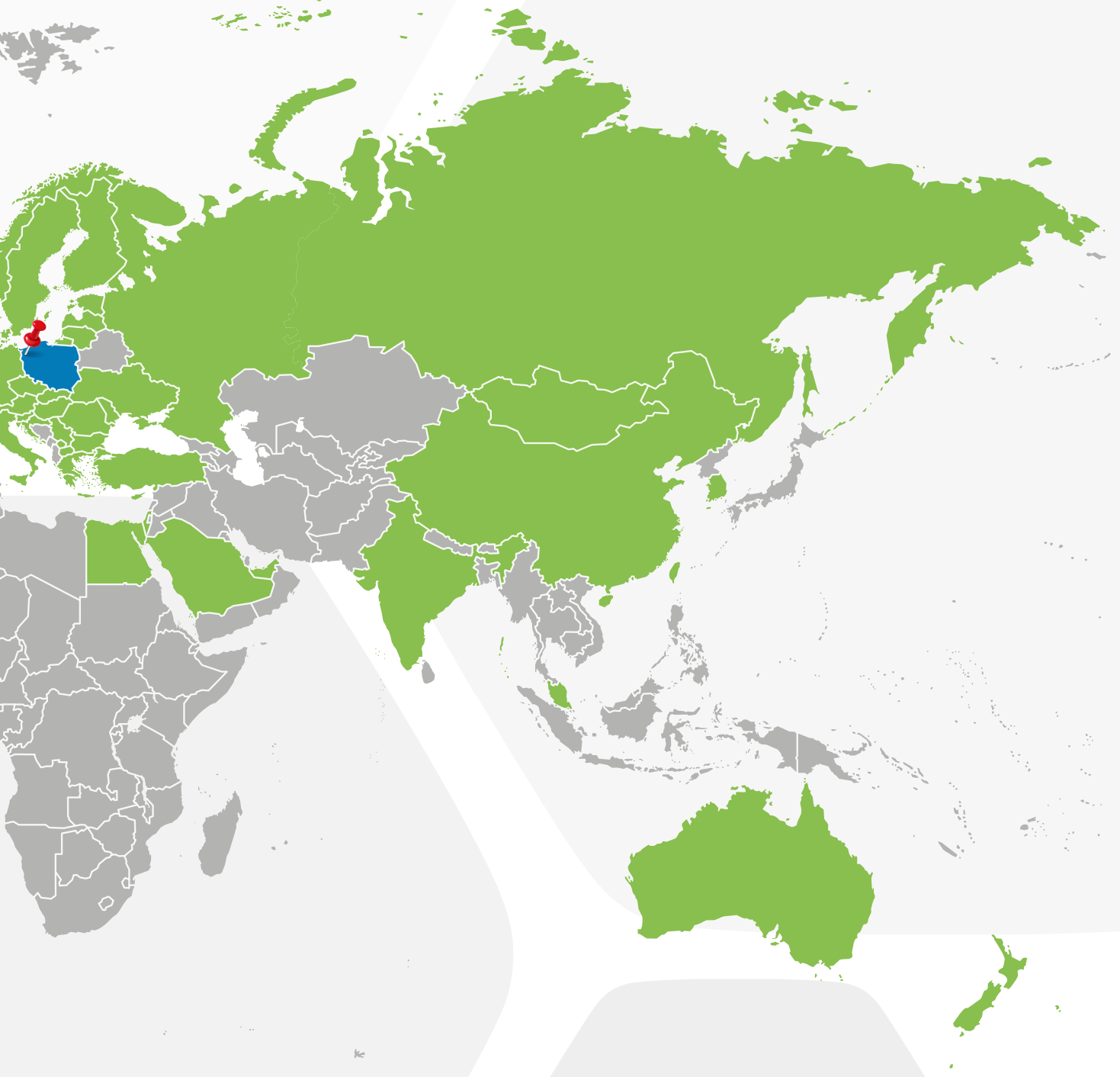



**Andrzej Pawłowski**  
Owner

We have built 20 years of experience, and from the very beginning our mission has been to offer products of the highest quality, durable, modern, unique, surprising, and unlike any others. Over the years, we have focused even more on this direction, and the smiles and joy of children, as well as the satisfaction of our clients, are the best reward for us. At the same time, they are also our commitment to providing the best possible customer service and to fostering a friendly atmosphere and relationships within the company.

Mit 20 Jahren Erfahrung ist es unsere Mission, Spielgeräte von höchster Qualität zu schaffen – langlebig, modern, einzigartig und überraschend. Das Lächeln der Kinder und die Zufriedenheit unserer Kunden sind unsere größte Belohnung – und zugleich unser Versprechen für besten Service sowie eine freundliche, partnerschaftliche Atmosphäre.



**Michał Soroka**  
Owner

We create our products in line with: "Amazing Playgrounds." Our goal is to design equipment that is not only engaging and unique, but also visually appealing, and offering children a wide variety of play opportunities. We ensure that our solutions spark imagination, stimulate the senses, and support the development of the youngest.

Of particular importance to us is creating play equipment accessible to children with disabilities, so they can play safely and integrate with their peers. Safety is our top priority. That's why all products undergo rigorous testing and meet the requirements of EN 1176 standards, guaranteeing children joy and complete freedom to play in safe conditions.

Unter dem Motto „Amazing Playgrounds“ entwickeln wir Geräte, die spannend, einzigartig und ästhetisch ansprechend sind. Sie regen Fantasie und Sinne an und fördern die Entwicklung der Kinder. Besonders wichtig ist uns Barrierefreiheit: auch Kinder mit Behinderungen sollen sicher spielen und sich integrieren können. Sicherheit hat oberste Priorität – alle Produkte erfüllen die EN 1176-Norm.



**Piotr Jaroszyński**  
Export Manager

For years, our playgrounds have been bringing smiles to the faces of children from all over the world. We have already gained the trust of 200 partners in more than 50 countries. From the snowy northern reaches of Scandinavia to the dry and hot regions of Australia. Every year, new distributors from new markets choose to join the Inter Play family. Children from different corners of the world give us priceless inspiration for our daily work, and we do our best to meet their expectations by designing playgrounds that stimulate both their physical and intellectual development.

This edition of our catalogue is special, as we are pleased to present the line of large SFERO structures—our response to the expectations of international markets and the result of many months of work by our experienced team of designers. Inter Play playgrounds have never been this exciting.

Unsere Spielplätze begeistern Kinder weltweit. Über 200 Partner in mehr als 50 Ländern – von Skandinavien bis Australien – vertrauen uns bereits. Jedes Jahr schließen sich neue Distributoren der Inter Play-Familie an. Kinder aus aller Welt inspirieren uns täglich, Spielplätze zu gestalten, die Bewegung und Kreativität fördern. Mit der neuen SFERO-Linie präsentieren wir eine internationale Innovation – Inter Play war noch nie so spannend.

We are a producer of playgrounds, trampolines, sports and fitness equipment, and urban furniture. We have been producing playgrounds since 2006.

Collaborating with us guarantees the highest quality certified products compliant with EN 1176, EN 15312 and EN 16630 standards, along with a continually expanding range of new products and innovations.

An important part of our offer includes integrative equipment that allows people with mobility disabilities to play. Over 10,000 projects in 52 countries across all continents testify to the trust of our clients and business partners.

Wir sind ein Hersteller von Spielplätzen, Trampolinen, Sport- und Fitnessgeräten sowie Stadtmobiliar. Wir produzieren Spielplätze seit 2006.

Die Zusammenarbeit mit uns garantiert Produkte höchster Qualität, die nach den Normen EN 1176, EN 15312 und EN 16630 zertifiziert sind, sowie ein ständig wachsendes Angebot an neuen Produkten und Innovationen.

Ein wichtiger Teil unseres Angebots umfasst integrative Geräte, die es Menschen mit Mobilitätsbehinderungen ermöglichen, zu spielen. Über 10.000 Projekte in 52 Ländern auf allen Kontinenten zeugen vom Vertrauen unserer Kunden und Geschäftspartner.



# How to download files | Herunterladen von Dateien

Go to the website: [www.inter-play.eu](http://www.inter-play.eu)

Besuchen Sie unsere Webseite: [www.interplay-spiel.de](http://www.interplay-spiel.de)

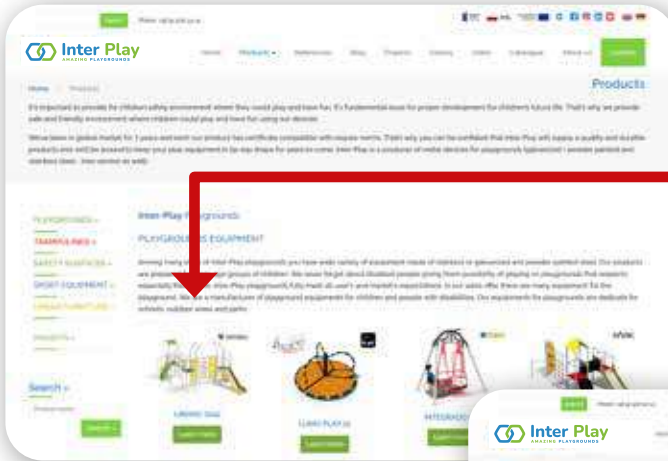

Click on the series of products  
Klicken Sie auf die gewünschte Serie

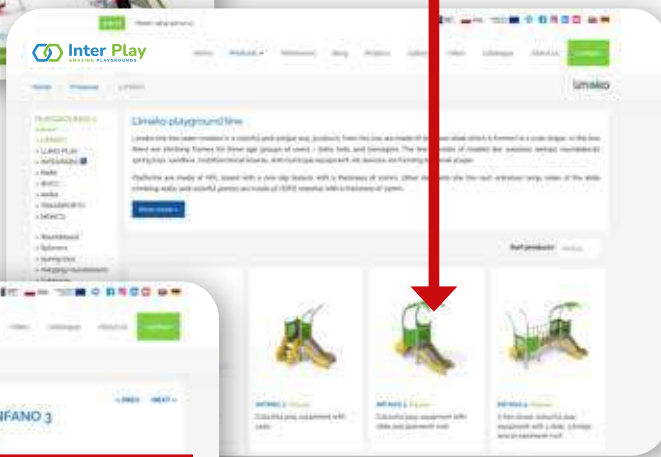

Click on the product  
Klicken Sie auf das Produkt

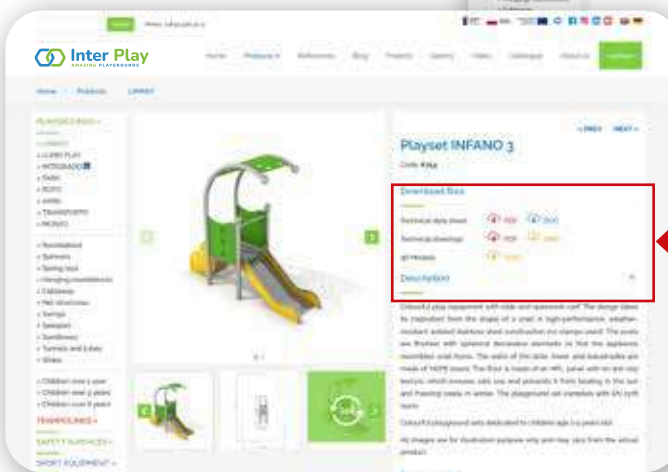

 Download the files  
Dateien herunterladen

Technical data sheet  
Ausschreibungstext  
Product specification  
Technische Informationen

Technical drawings  
Technische Zeichnungen  
Dimensions useful for design  
Abmessungen, die für das Design  
nützlich sind

3D Models  
3D Modelle  
3D DWG model for designers  
3D Modell für Visualisierungsdesign

 Download PDF  
PDF herunterladen

 Download PDF  
PDF herunterladen

 Download DWG  
DWG herunterladen

 Download DOC  
DOC herunterladen

 Download DWG  
DWG herunterladen

## Projects | Spielplatzprojekte

Many ready-made project proposals are available for download from our website. If you are looking for inspiration that will help you to create nice and unique playground feel free to use one of them.

Based on our equipment, you can set up a complete playground or a sports facility for children of all ages and abilities.

Playground projects have been divided into thematic groups. All you need to do is select the group of products you are interested in and you will see the available proposals. The site contains many ready-made visualizations. We hope that the presented solutions will inspire you to create fantastic places for recreation.

Auf unserer Website finden Sie auch beispielhafte Spielplatzprojekte. Auf einfache und bewährte Weise lassen sich interessante Objekte herstellen. Wir bieten multifunktionelle Spielplatzgeräte in verschiedenen Größen an, die für Kinder aller Altersstufen konzipiert sind. Durch geschickte Auswahl der Spielgeräte können Sie einen eigenen Spielplatz für bestimmte Zielgruppe erstellen - z.B. Kinderkrippe, Kindergarten, Schule, Wohnsiedlung, Park oder Hotel.

Beispielprojekte auf der Website stehen Ihnen kostenlos zur Verfügung. Laden Sie technische Spezifikationen, DWG-Zeichnungen und Visualisierung herunter.

limako



SALTO



FITNESS



integrado



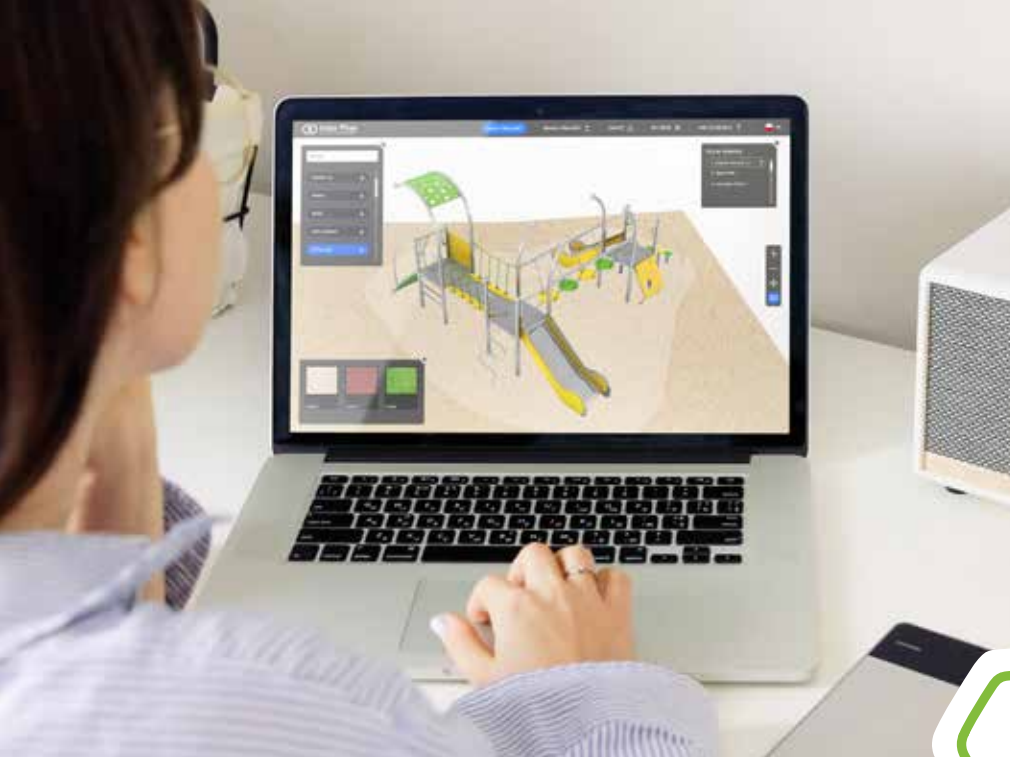

# Inter Play Studio

Coming soon on:  
Bald verfügbar auf:  
[inter-play.eu](http://inter-play.eu)  
[interplay-spiel.de](http://interplay-spiel.de)

## Free online application to design your playground in minutes.

Inter Play Studio is our upcoming web tool that lets you sketch a site, place equipment from the Inter Play range, and instantly see safety zones and space requirements. It's perfect for quick feasibility checks and early-stage concepts you can show to decision makers.

## Kostenlose Online-Anwendung, um Ihren Spielplatz in wenigen Minuten zu planen.

Inter Play Studio ist unser bald verfügbares Web-Tool, mit dem Sie ein Gelände skizzieren, Geräte aus dem Inter-Play-Sortiment platzieren und sofort Sicherheitsbereiche sowie Flächenbedarf sehen. Ideal für schnelle Machbarkeitsprüfungen und frühe Konzeptskizzen, die Sie Entscheidungsträgern zeigen können.

### What it is

A simple, browser-based planner for playgrounds. Draw or set the size of your plot, drag-and-drop equipment, and preview the layout in 2D or 3D with automatic safety clearances.

### What it can do

- Draw your area on a map or grid and set exact dimensions.
- Drag-and-drop equipment from our catalogue; filter by function, series, age group, landscape, or surface.
- Automatic safety zones generated from product specs to help meet standards.
- Instant fit check—see how many items realistically fit on your site.
- 2D & 3D views for clarity when presenting ideas.
- Live measurements (lengths, widths, total area) to keep budgets and quotes on track.
- Save & share visuals for internal approvals and stakeholder presentations.
- Free for everyone—no software to install.

### Was es ist

Ein einfacher, browserbasierter Planer für Spielplätze. Zeichnen oder definieren Sie die Größe Ihres Grundstücks, platzieren Sie Geräte per Drag-and-drop und sehen Sie die Anordnung in 2D oder 3D – mit automatischen Sicherheitsabständen.

### Was es kann

- Zeichnen Sie Ihre Fläche auf einer Karte oder einem Raster und legen Sie exakte Abmessungen fest.
- Drag-and-drop von Geräten aus unserem Katalog; Filter nach Funktion, Serie, Altersgruppe, Landschaft oder Belag.
- Automatische Sicherheitsbereiche gemäß Produktspezifikationen – zur normgerechten Planung.
- Sofortiger „Passt-es?“-Check – sehen Sie, wie viele Geräte realistisch auf Ihre Fläche passen.
- 2D- & 3D-Ansichten für maximale Verständlichkeit in Präsentationen.
- Live-Maße (Längen, Breiten, Gesamtfläche), damit Budgets und Angebote im Rahmen bleiben.
- Speichern & teilen von Visualisierungen für interne Freigaben und Stakeholder-Präsentationen.
- Für alle kostenlos – keine Installation erforderlich.

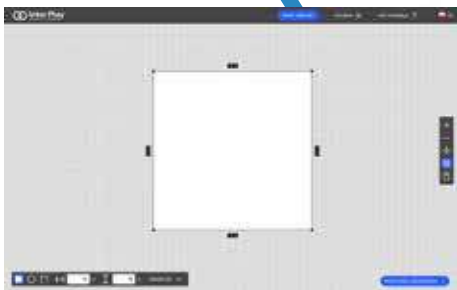
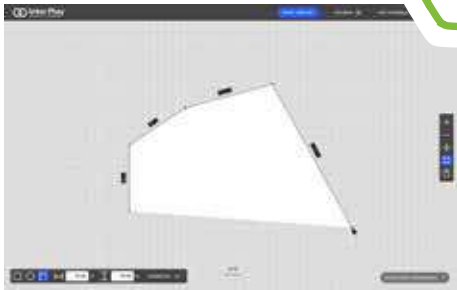

### Why use it

- Prototype early. Test ideas before detailed design begins.
- Win buy-in. Clear visuals help convince councils, schools, and investors.
- Reduce rework. Safety clearances and space rules are visible from the start.
- Plan faster. Answer "Will it fit?" in seconds.
- Choose smarter. Compare options, swap items, and refine the layout on the fly.

Launching soon on [inter-play.eu](https://inter-play.eu)  
 Questions or early access? [export@inter-play.eu](mailto:export@inter-play.eu)

### Warum es sich lohnt

- Früh prototypen. Ideen testen, bevor die Detailplanung startet.
- Zustimmung gewinnen. Klare Visualisierungen überzeugen Kommunen, Schulen und Investoren.
- Nacharbeit reduzieren. Sicherheitsabstände und Flächenregeln sind von Anfang an sichtbar.
- Schneller planen. Die Frage „Passt es?“ in Sekunden beantworten.
- Klüger auswählen. Varianten vergleichen, Geräte tauschen und das Layout spontan verfeinern.

Startet in Kürze auf [inter-play.eu](https://inter-play.eu)  
 Fragen oder früherer Zugang? [info@interplay-spiel.de](mailto:info@interplay-spiel.de)

SFERO 



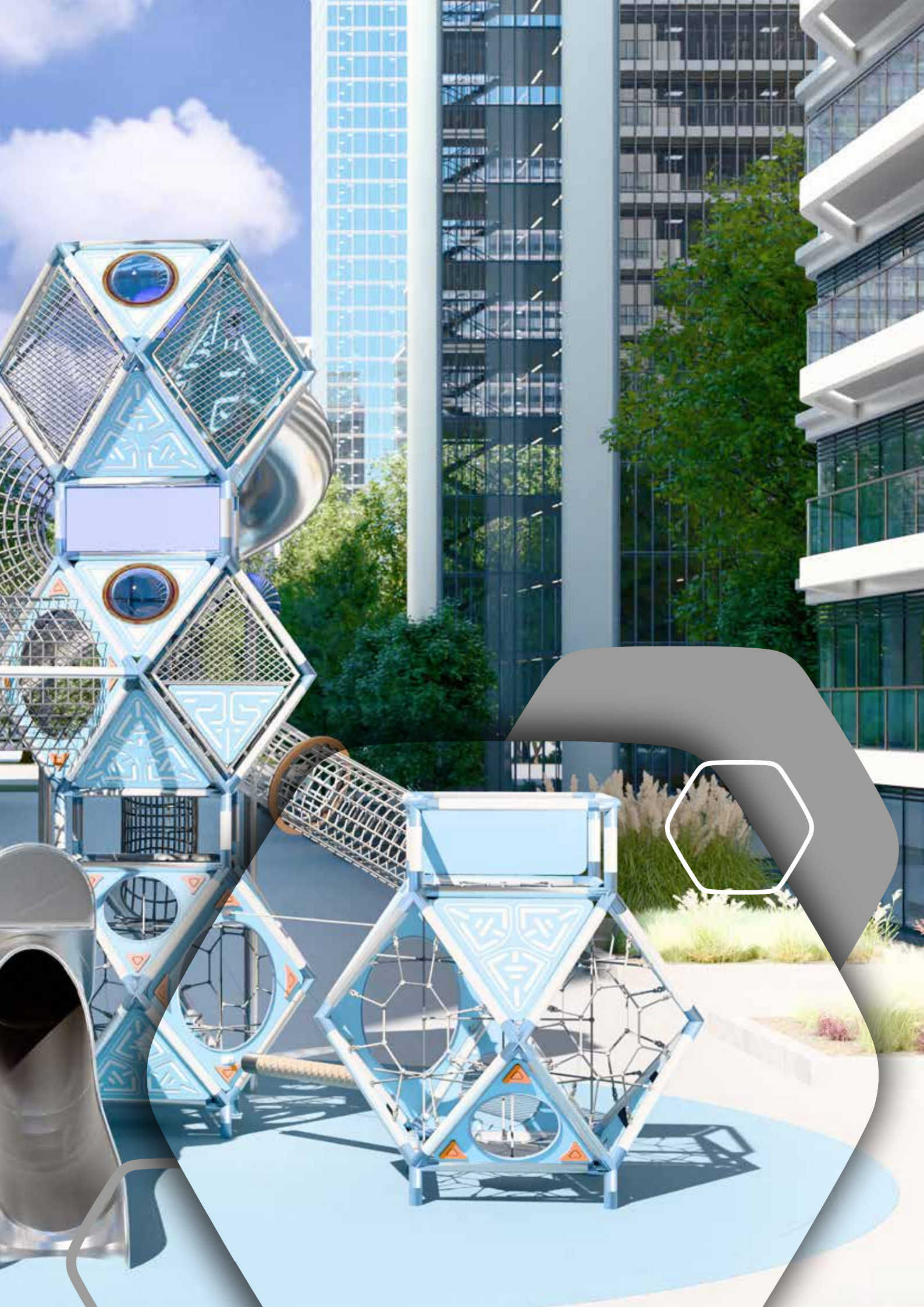

# SFERO Series

A space, underwater, or forest base. It sparks imagination and offers many opportunities for play.

# Serie SFERO

Eine Weltraumstation, Unterwasser- oder Wald-Basis. Sie regt die Fantasie an und bietet zahlreiche Spielmöglichkeiten.

HDPE panels with fantastic patterns emphasize the character of the base, transporting children into a world of imagination.

HDPE-Platten mit fantastischen Mustern unterstreichen den Charakter der Basis und versetzen die Kinder in eine Welt der Fantasie..

The powder-coated steel structure ensures safety during play.

Die pulverbeschichtete Stahlkonstruktion sorgt für Sicherheit beim Spielen.

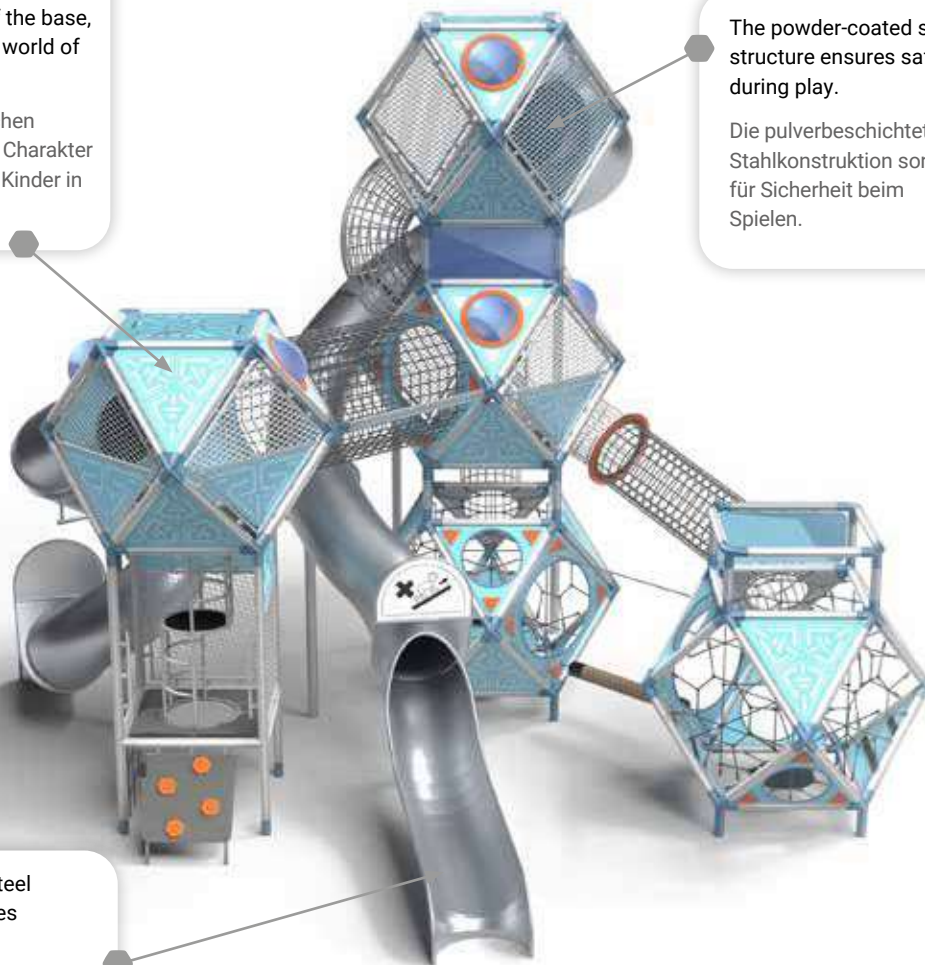

A slide made of stainless steel or colorful plastic. It provides excitement and great fun.

Eine Rutsche aus Edelstahl oder farbenfrohem Kunststoff sorgt für Nervenkitzel und großen Spielspaß.



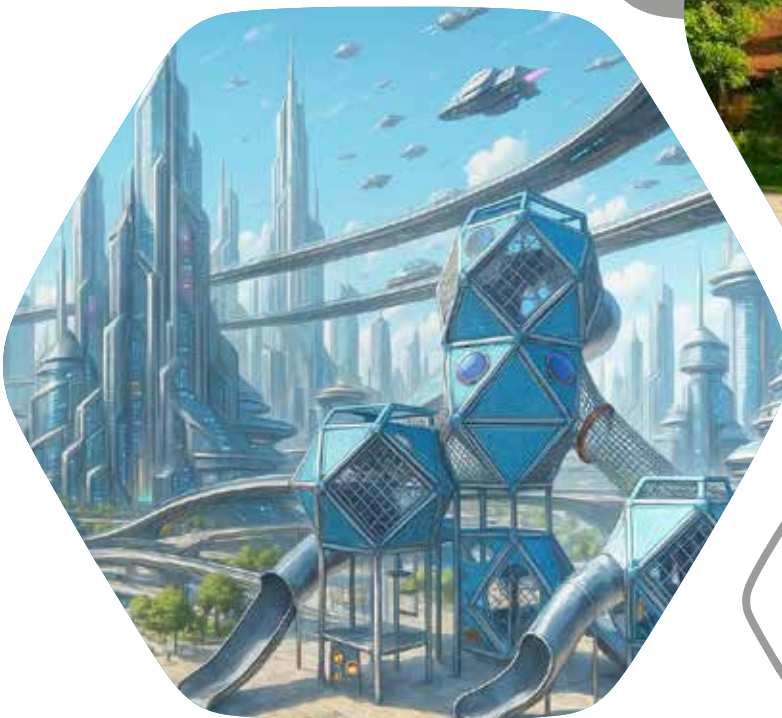

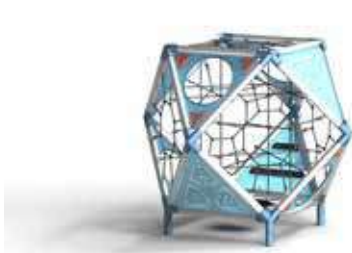

**SFERO SPACE 1-1**  
01-SF-711-S



**SFERO SPACE 1-2**  
01-SF-712-X-S



**SFERO SPACE 2-1**  
01-SF-721-S



**SFERO SPACE 2-2**  
01-SF-722-X-S



**SFERO SPACE 3-1**  
01-SF-731-X-S



**SFERO SPACE 4-1**  
01-SF-741-X-S



<b>SFERO SPACE 1-1</b>	01-SF-711-S	1,93 x 1,93 x 2,18	5,93 x 5,93	2,18	6+	15
<b>SFERO SPACE 1-2</b>	01-SF-712-X-S	6,85 x 2,7 x 3,09	10,85 x 6,7	2,18	6+	18
<b>SFERO SPACE 2-1</b>	01-SF-721-S	2,14 x 2,14 x 4,62	6,6 x 6,6	2,76	6+	16
<b>SFERO SPACE 2-2</b>	01-SF-722-X-S	3,83 x 4,07 x 4,62	6,6 x 7,5	2,76	6+	19
<b>SFERO SPACE 3-1</b>	01-SF-731-X-S	7,47 x 4,3 x 4,62	10,1 x 7,5	2,76	6+	39
<b>SFERO SPACE 4-1</b>	01-SF-741-X-S	9,6 x 8,18 x 4,62	14 x 11,8	2,76	6+	61
<b>SFERO SPACE 5-1</b>	01-SF-751-X-S	7,3 x 8,8 x 7,06	10,5 x 12,7	2,76	6+	71

**SFERO SPACE 5-1**  
01-SF-751-X-S





**SFERO FOREST 1-1**  
01-SF-711-F



**SFERO FOREST 1-2**  
01-SF-712-P-F



**SFERO FOREST 2-1**  
01-SF-721-F



**SFERO FOREST 2-2**  
01-SF-722-P-F



**SFERO FOREST 3-1**  
01-SF-731-P-F



**SFERO FOREST 4-1**  
01-SF-741-P-F



<b>SFERO FOREST 1-1</b>	01-SF-711-F	1,93 x 1,93 x 2,18	5,93 x 5,93	2,18	6+	15
<b>SFERO FOREST 1-2</b>	01-SF-712-P-F	6,85 x 2,7 x 3,09	10,85 x 6,7	2,18	6+	18
<b>SFERO FOREST 2-1</b>	01-SF-721-F	2,14 x 2,14 x 4,62	6,6 x 6,6	2,76	6+	16
<b>SFERO FOREST 2-2</b>	01-SF-722-P-F	3,83 x 4,07 x 4,62	6,6 x 7,5	2,76	6+	19
<b>SFERO FOREST 3-1</b>	01-SF-731-P-F	7,47 x 4,3 x 4,62	10,1 x 7,5	2,76	6+	39
<b>SFERO FOREST 4-1</b>	01-SF-741-P-F	9,6 x 8,18 x 4,62	14 x 11,8	2,76	6+	61
<b>SFERO FOREST 5-1</b>	01-SF-751-P-F	7,3 x 8,8 x 7,06	10,5 x 12,7	2,76	6+	71



**SFERO FOREST 5-1**  
01-SF-751-P-F



limako







**The LIMAKO series is snail-inspired and uniquely designed.**

**Die LIMAKO-Serie hat ein einzigartiges, von Schnecken inspiriertes Design und schöne, lebendige Farben.**

A stainless steel construction maintains its modern look for years and does not require painting.

Eine Edelstahlkonstruktion bewahrt ihr modernes Aussehen über Jahre und erfordert keine Lackierung.

Durable polypropylene ropes, reinforced with a steel core ensures safety while playing.

Langlebige Polypropylen-Seile, sind mit einem Stahlkern verstärkt und sorgen für Sicherheit beim Spielen.

Entrance gangways and the climbing walls are made of HDPE which do not tear off and are easy to keep clean. Its vivid colours enhance the aesthetic value of the playground

Die Kletterwände sind aus HDPE-Platten hergestellt, die beim intensiven Nutzung nicht verschleßen und leicht zu reinigen sind. Ihre lebendigen Farben unterstreichen den ästhetischen Wert des Spielplatzes. erfordert keine Lackierung.

Extremely durable HPL platform board is equipped with non-slip structure that ensures safety and limits possibility of uncontrolled slippage during play.

Langlebige HPL-Platte mit einer rutschfesten Struktur gewährleistet die Sicherheit und begrenzt die Möglichkeit des unkontrollierten Rutschens während des Spiels.

### Slides | Rutschen

- Option I - stainless steel
- Option II - plastic
- Variante I - Edelstahl
- Variante II - Kunststoff

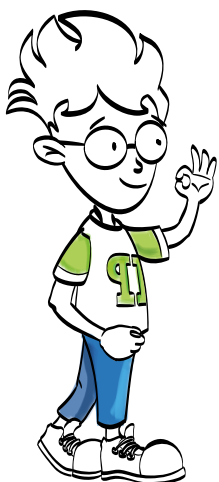

### Installation | Montagearten

- Option I - to embed
- Option II - concrete version
- Variante I - zum Einbetonieren
- Variante II - zum Verschrauben





**INFANO 1**  
K751



**INFANO 2**  
K752



**INFANO 3**  
K753



**INFANO 5**  
K755



<b>INFANO 1</b>	K751	1,33 x 1,00 x 2,25	4,33 x 4,00	0,55	1+	2
<b>INFANO 2</b>	K752	2,04 x 1,44 x 2,08	5,54 x 4,44	0,59	1+	3
<b>INFANO 3</b>	K753	2,50 x 0,80 x 2,00	6,01 x 3,78	0,59	1+	3
<b>INFANO 5</b>	K755	3,59 x 3,09 x 2,49	6,89 x 6,09	0,59	1+	5
<b>INFANO 4</b>	K754	3,08 x 2,59 x 2,49	6,08 x 6,09	0,59	1+	5
<b>INFANO 6</b>	K756	3,39 x 2,93 x 2,25	6,89 x 5,93	0,59	1+	4



**INFANO 4**  
K754



**INFANO 6**  
K756





**DOMETO 1-1**  
K511



**DOMETO 1-2**  
K512



**DOMETO 2-1**  
K521









**DOMETO 2-2**  
K522



**DOMETO 2-3**  
K523



						
<b>DOMETO 1-1</b>	K511	3,42 x 1,70 x 2,40	6,92 x 4,70	0,90	3+	3
<b>DOMETO 1-2</b>	K512	3,42 x 1,70 x 2,80	6,92 x 4,70	0,90	3+	3
<b>DOMETO 2-1</b>	K521	5,60 x 2,01 x 2,80	9,10 x 5,01	0,90	3+	5
<b>DOMETO 2-2</b>	K522	4,48 x 3,94 x 2,80	7,48 x 7,94	0,90	3+	5
<b>DOMETO 2-3</b>	K523	6,18 x 3,94 x 2,80	9,18 x 7,94	0,90	3+	5
<b>DOMETO 3-1</b>	K531	6,17 x 5,60 x 2,80	9,17 x 9,10	0,90	3+	8
<b>DOMETO 3-2</b>	K532	8,85 x 3,75 x 2,80	12,35 x 7,25	0,90	3+	9
<b>DOMETO 4-1</b>	K541	6,12 x 6,80 x 2,80	10,12 x 9,80	0,90	3+	12



**DOMETO 3-1**  
K531



**DOMETO 3-2**  
K532



**DOMETO 4-1**  
K541





**DOMO 1-1**  
K611



**DOMO 1-2**  
K612









**DOMO 2-1**  
K621



**DOMO 4-1**  
K641



								
<b>DOMO 1-1</b>	K611	4,39 x 6,26 x 3,73		7,39 x 9,80	2,50	6+	9	
<b>DOMO 1-2</b>	K612	6,65 x 3,67 x 3,56		10,38 x 7,12	2,50	6+	10	
<b>DOMO 2-1</b>	K621	6,02 x 3,33 x 3,73		9,02 x 7,17	2,50	6+	8	
<b>DOMO 2-2</b>	K622	6,76 x 3,59 x 3,73		10,27 x 6,60	2,50	6+	4	
<b>DOMO 2-3</b>	K623	7,95 x 2,62 x 3,73		11,93 x 5,62	2,50	6+	8	
<b>DOMO 2-4</b>	K624	7,57 x 5,44 x 3,73		11,26 x 8,69	2,50	6+	14	
<b>DOMO 4-1</b>	K641	9,73 x 6,82 x 3,73		13,23 x 10,32	2,50	6+	14	



**DOMO 2-2**  
K622



**DOMO 2-3**  
K623



**DOMO 2-4**  
K624











**DOMO 3-1**  
K631



**DOMO 3-2**  
K632



**DOMO 3-3**  
K633

						
<b>DOMO 3-1</b>	K631	8,22 x 5,25 x 3,56	12,22 x 8,25	2,50	6+	11
<b>DOMO 3-2</b>	K632	11,03 x 4,15 x 3,87	14,49 x 7,65	2,50	6+	15
<b>DOMO 3-3</b>	K633	9,62 x 3,42 x 3,43	12,90 x 6,92	2,50	6+	15
<b>RIDO 1</b>	K801	3,70 x 2,25 x 2,35	7,20 x 5,25	0,59	1+	5
<b>RIDO 2</b>	K802	2,57 x 0,91 x 1,85	5,57 x 3,91	0,35	1+	4



**RIDO 1**  
K801



**RIDO 2**  
K802





**ESKALO 1**  
K701



**ESKALO 2**  
K702



**ESKALO 3**  
K703

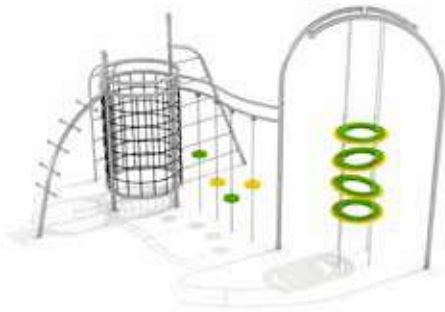







**ESKALO 4**  
K704



**ESKALO 5**  
K705



**ESKALO 6**  
K706

								
<b>ESKALO 1</b>	K701	3,67 x 1,73 x 2,90	7,37 x 5,43	2,00	6+	8		
<b>ESKALO 2</b>	K702	4,11 x 2,15 x 2,84	7,65 x 5,25	2,00	6+	9		
<b>ESKALO 3</b>	K703	4,60 x 3,80 x 2,90	8,07 x 7,37	2,00	6+	16		
<b>ESKALO 7</b>	K707	6,77 x 6,20 x 2,89	11,03 x 9,20	2,00	6+	16		
<b>ESKALO 4</b>	K704	5,10 x 3,56 x 2,85	8,34 x 7,04	2,00	6+	11		
<b>ESKALO 5</b>	K705	6,97 x 2,95 x 3,20	10,30 x 7,03	2,00	6+	14		
<b>ESKALO 6</b>	K706	6,09 x 1,73 x 2,89	9,62 x 5,40	2,00	6+	12		
<b>ESKALO 8</b>	K708	4,63 x 5,22 x 3,31	8,62 x 8,22	2,00	6+	15		



**ESKALO 7**  
K707



**ESKALO 8**  
K708





**VERGO**  
K301



**BIRDO**  
K302



**KOMBINO**  
K309



**ARCO**  
K303



<b>VERGO</b>	K301	2,75 x 0,35 x 2,35	7,50 x 1,75	1,30	3+	2
<b>BIRDO</b>	K302	3,34 x 1,00 x 2,40	7,50 x 2,35	1,30	3+	2
<b>ARCO</b>	K303	4,66 x 1,27 x 2,50	7,50 x 4,85	1,30	3+	4
<b>PENDOLO</b>	K308	3,83 x 2,08 x 2,52	3,17 x 7,50	1,30	1+	2
<b>NESTO</b>	K310	3,03 x 2,17 x 2,52	2,35 x 7,50	1,30	3+	2
<b>FRAMO</b>	K307	2,37 x 2,08 x 2,52	7,5 x 1,75	1,30	3+	1
<b>KOMBINO</b>	K309	6,14 x 2,08 x 2,52	5,58 x 7,50	1,30	3+	4
<b>BALANCILO 1</b>	K201	2,65 x 0,50 x 0,85	4,65 x 2,50	0,80	3+	2
<b>BALANCILO 2</b>	K202	2,85 x 0,50 x 1,00	4,85 x 2,50	0,80	3+	2

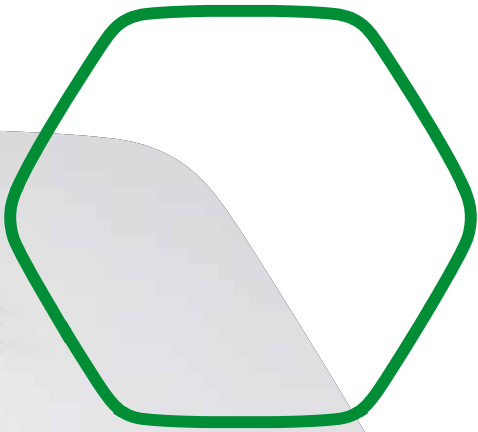

**PENDOLO**  
K308



**FRAMO**  
K307



**BALANCILO 1**  
K201



**BALANCILO 2**  
K202



**NESTO**  
K310



**MIKSI**  
IS-IN-301



**ENIRO**  
K304







**TURNADO**  
K101



**RANDO**  
K104



						
<b>MIKSI</b>	IS-IN-301	7,54 x 2,25 x 2,52	6,89 x 7,80	1,30	3+	4
<b>ENIRO</b>	K304	5,05 x 3,18 x 2,40	7,50 x 3,15	1,30	3+	4
<b>TURNADO</b>	K101	1,50 x 1,50 x 0,80	5,50 x 5,50	1,00	3+	6
<b>RANDO</b>	K104	1,22 x 1,22 x 1,10	5,22 x 5,22	1,00	3+	5
<b>PLATFORMO</b>	K102	1,50 x 1,50 x 0,80	5,50 x 5,50	1,00	3+	6
<b>POKALO</b>	K105	1,80 x 1,80 x 0,77	5,80 x 5,80	1,00	3+	8
<b>GLOBO</b>	K103	1,22 x 1,22 x 1,10	5,22 x 5,22	1,00	3+	8



**POKALO**  
K105









**PLATFORMO**  
K102



**GLOBO**  
K103





						
<b>TELERO 1</b>	K106-GV	0,70 x 0,70 x 0,40	6,70 x 6,70	1,00	3+	2
<b>TELERO 2</b>	K107-GV	2,00 x 2,00 x 0,50	8,00 x 8,00	1,00	3+	5
<b>SIDI 1</b>	K411	0,63 x 0,46 x 0,79	3,46 x 3,63	0,46	3+	1
<b>SIDI 2</b>	K412	1,66 x 0,46 x 0,79	4,66 x 3,46	0,46	3+	3
<b>SIDI 3</b>	K413	2,00 x 2,31 x 0,78	5,31 x 5,00	0,46	3+	4
<b>SIDENTA 2</b>	K422	1,86 x 1,10 x 0,94	4,86 x 4,10	0,46	3+	4
<b>RINGO</b>	K441	1,50 x 1,50 x 0,43	4,50 x 4,50	0,46	3+	8
<b>SALTI 2</b>	K432	1,10 x 1,10 x 0,43	4,10 x 4,10	0,46	3+	4
<b>SALTI 1</b>	K431	0,40 x 0,40 x 0,41	3,40 x 3,40	0,46	3+	1



**TELERO 1**  
K106-GV

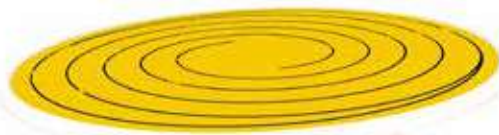

**TELERO 2**  
K107-GV



**SIDI 1**  
K411



**SIDI 2**  
K412



**SIDI 3**  
K413



**SIDENTA 2**  
K422



**SALTI 1**  
K431



**SALTI 2**  
K432

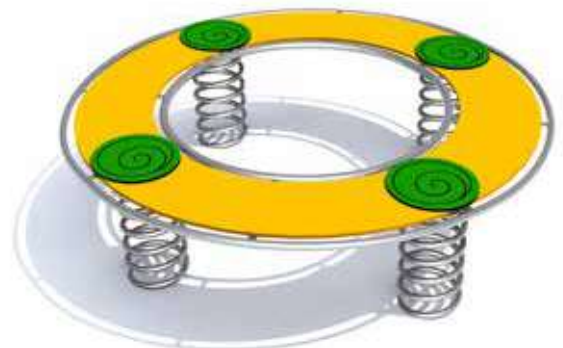

**RINGO**  
K441



**VOCO**  
K1151



**TABLO**  
K930



**STATIVO**  
K940



**TRANSIRO 20**  
K1101-20

**TRANSIRO 25**  
K1101-25



<b>VOCO</b>	K1151	0,41 x 0,15 x 1,29	-		3+	2
<b>TABLO</b>	K930	48,5 x 98,5	-			
<b>STATIVO</b>	K940	1,50 x 0,07 x 1,25	-			
<b>TRANSIRO 20</b>	K1101-20	25,42 x 4,57 x 4,50	24,73 x 4,00	0,99	3+	1
<b>TRANSIRO 25</b>	K1101-25	30,42 x 4,57 x 4,65	29,73 x 4,00	0,99	3+	1



**RUBO**  
K920







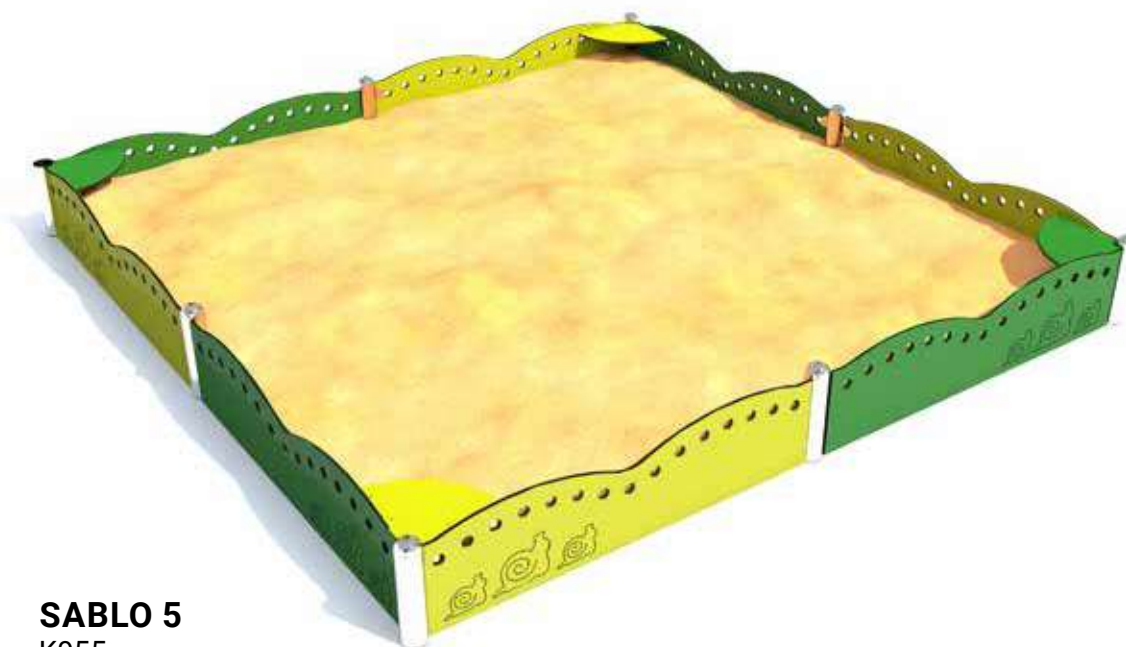

**SEGO 1**  
K901



**SEGO 2**  
K902



**SABLO 5**  
K955

								
<b>RUBO</b>	K920	0,48 x 0,72 x 1,05	-	-	-	-	-	
<b>SEGO 1</b>	K901	1,55 x 0,61 x 0,83	-	-	-	-	-	
<b>SEGO 2</b>	K902	1,60 x 0,66 x 1,05	-	-	-	-	-	
<b>SABLO 1</b>	K951	1,50 x 1,50 x 0,35	4,50 x 4,50	-	-	1+	5	
<b>SABLO 2</b>	K952	2,00 x 2,00 x 0,35	5,00 x 5,00	-	-	1+	9	
<b>SABLO 3</b>	K953	1,50 x 1,50 x 0,35	4,50 x 4,50	-	-	1+	5	
<b>SABLO 4</b>	K954	2,00 x 2,00 x 0,35	5,00 x 5,00	-	-	1+	9	
<b>SABLO 5</b>	K955	2,92 x 2,92 x 0,35	5,92 x 5,92	-	-	1+	16	

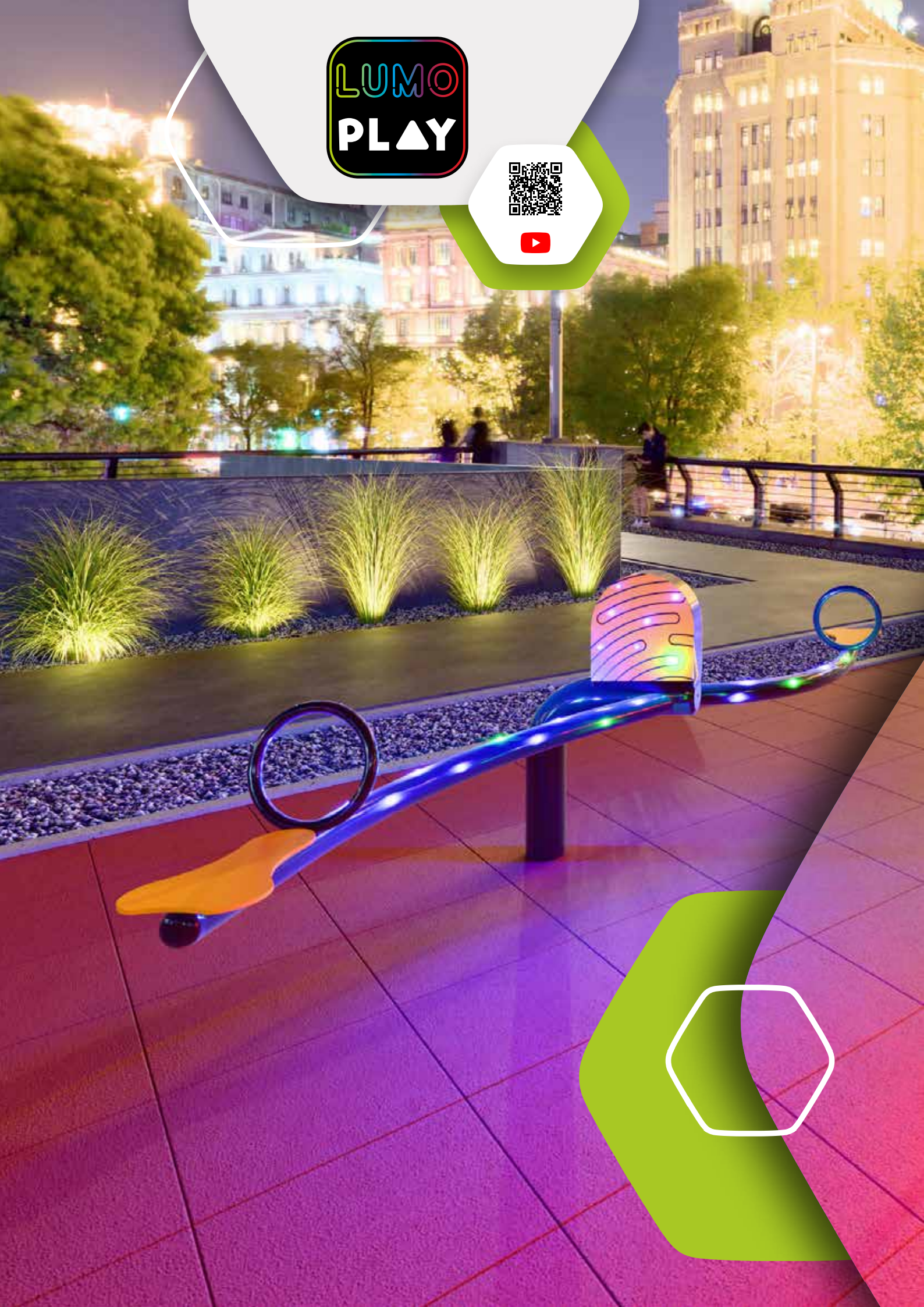

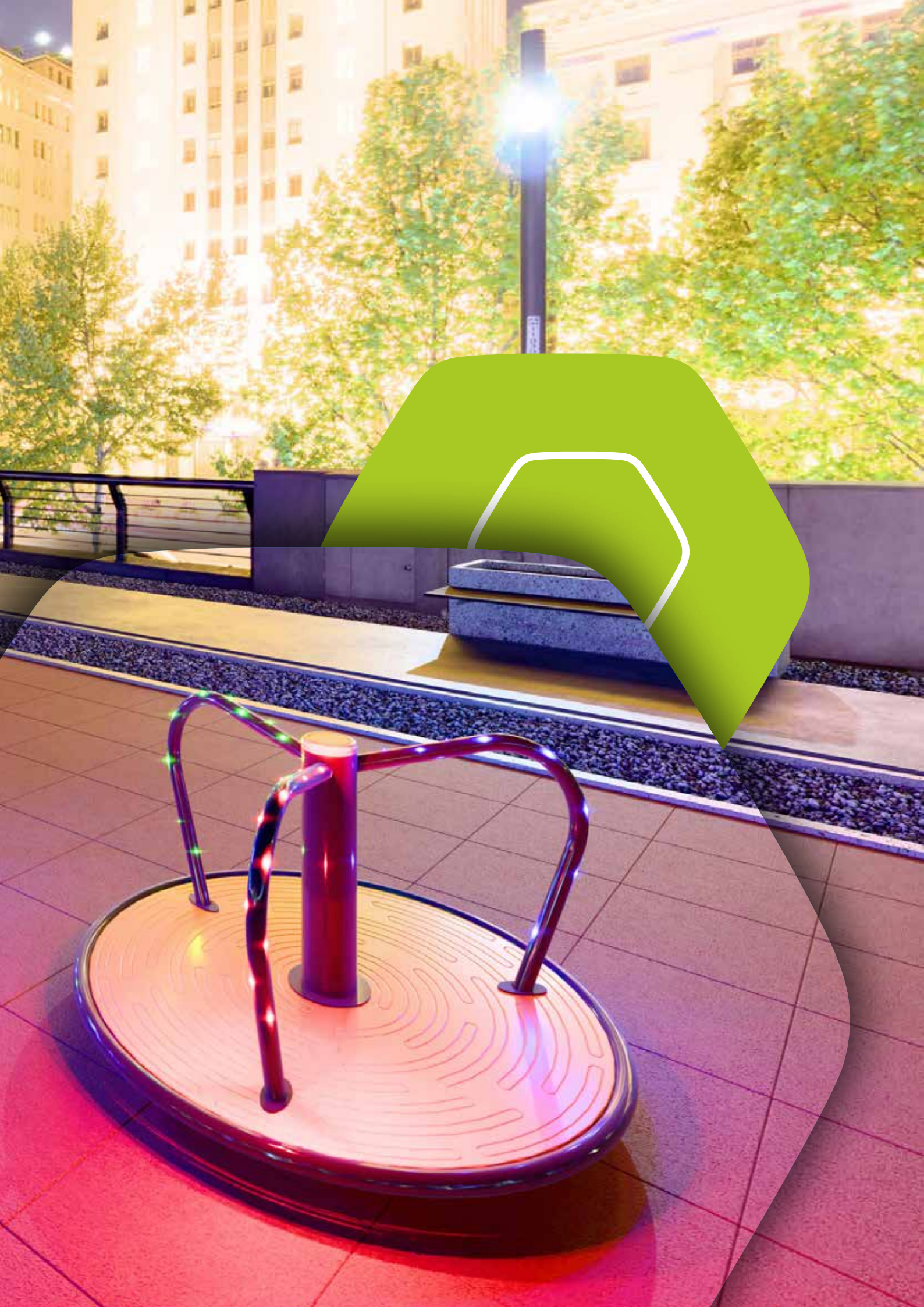



# LIGHT & SOUND

**LUMO PLAY is an unique light and sound system - it generates light and sound while device is in motion, thanks to which the product is colourfully illuminated and at the same time plays funny melodies. It takes the playground to higher level, making it interactive, modern and attractive for children of all ages.**

**LUMO PLAY ist ein einzigartiges Licht- und Soundsystem - es erzeugt Licht und Ton, wenn das Spielplatzgerät bewegt wird, so dass das Produkt farbig leuchtet und gleichzeitig lustige Melodien spielt. LUMO PLAY bringt den Spielplatz auf ein höheres Niveau und macht ihn interaktiv, modern und attraktiv für Kinder jeden Alters.**

## Light

When the roundabout is put in motion it illuminates colourfully with Fibre optic lights.

## Licht

Wenn Sie das Spielzeug in Bewegung setzen, blinkt das Spielzeug mit farbigen Fibre optic-Leuchten.

## Music

When device is in motion music starts to play. Built-in speaker provides high quality sound.

## Musik

Wenn Sie das Spielzeug in Bewegung setzen, werden Sie Musik hören. Die eingebauten Lautsprecher sorgen für die richtige Klangqualität.

## App

Control it by mobile phone downloading LUMO PLAY App from Google Play or App Store.

## App

Laden Sie die LUMO PLAY App von Google Play oder App Store herunter und steuern Sie Musik und Licht.

## Play your favourite music

Connect it to Spotify, YouTube or Tidal and play your favourite tunes and songs while using it.

## Spielen Sie Ihre Lieblingsmusik ab

Verbinden Sie sich mit Spotify, YouTube oder Tidal und spielen Sie Ihre Lieblingslieder ab.



## Administrator

The app allows to override music and light settings. Depends on the time of day, modify the volume or ON/OFF settings.

## Administrator

Die App ermöglicht übergeordnete Musik-, und Lichteinstellungen. Ändern Sie die Lautstärke- oder ON/OFF-Einstellungen je nach Tageszeit

## Power

Power is generated by movement, so external power supply or battery is not required

## Strom

Der Strom wird während der Bewegung des Spielzeugs erzeugt. Daher benötigen die Spielplatzgeräte mit dem LUMO PLAY System weder eine Batterie noch einen externen Anschluss



LUMO PLAY APP



1



2



3



4





**NORTE 130 LUMO PLAY**  
GK-RO-201-LP-H



**NORTE 130 LUMO**  
GK-RO-201-L-H



<b>NORTE 130 LUMO PLAY</b>	GK-RO-201-LP	1.30 x 1.30 x 0.80 m	5.30 x 5.30 m	1.0 m	2+	4
<b>NORTE 130 LUMO</b>	GK-RO-201-L-H	1.30 x 1.30 x 0.80 m	5.30 x 5.30 m	1.0 m	2+	4

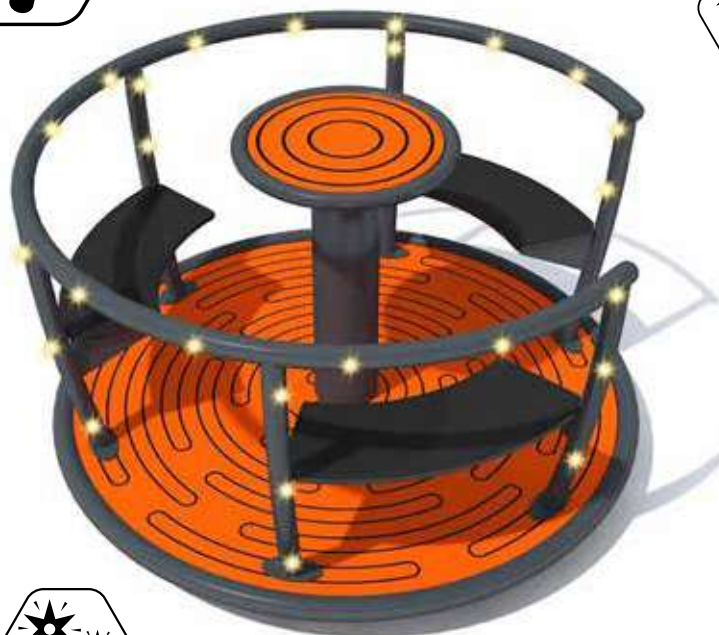
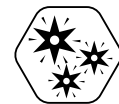

**TORNADO 130 LUMO PLAY**  
GM0147-1p-LP-H

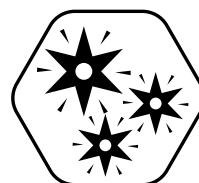
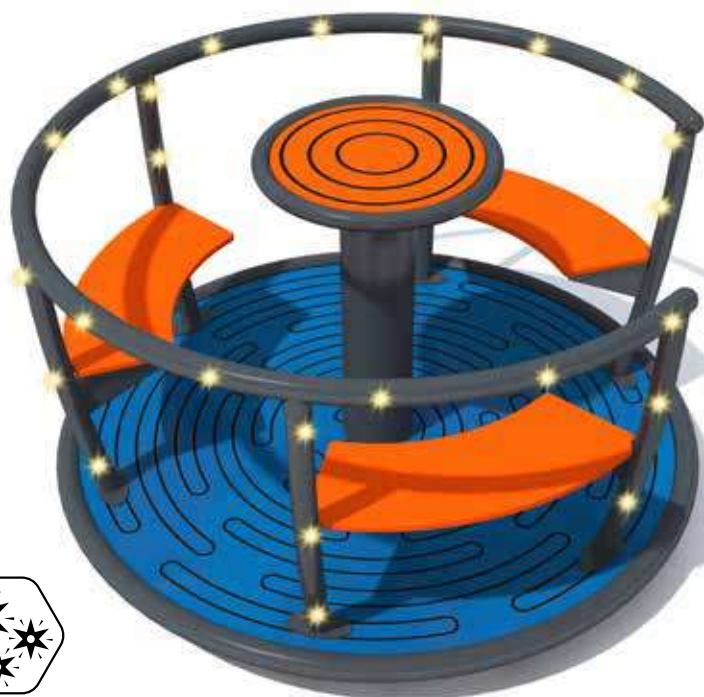

**TORNADO 130 LUMO**  
GM0147-1P-L-H



<b>TORNADO 130 LUMO PLAY</b>	GM0147-1p-LP-H	1,30 x 1,30 x 0,77	5,30 x 5,30	1,0	2+	4
<b>TORNADO 130 LUMO</b>	GM0147-1P-L-H	1,30 x 1,30 x 0,77	5,30 x 5,30	1,0	2+	4

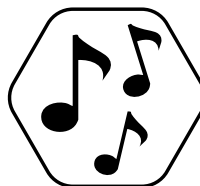

**ATOMIC LUMO PLAY**  
IS-IN-111-LP

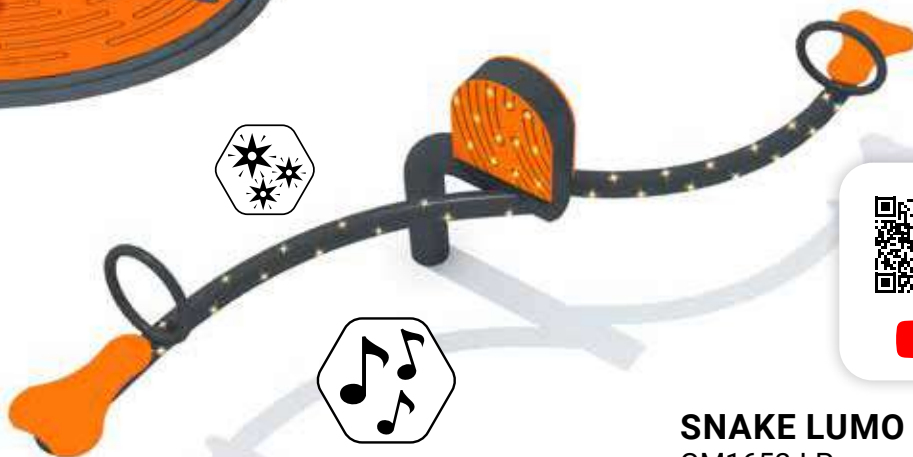

**SNAKE LUMO PLAY**  
GM1652-LP



**FESTO MINI LUMO**  
IS-MM-001



**FESTO LUMO**  
IS-MM-002



<b>ATOMIC LUMO PLAY</b>	IS-IN-111-LP			2,14 x 2,14 x 0,83	6,14 x 6,14	1,00	3+	9
<b>SNAKE LUMO PLAY</b>	GM1652-LP			3,28 x 1,52 x 0,80	6,28 x 4,52	0,86	3+	2
<b>FESTO MINI LUMO</b>	IS-MM-001			1,42 x 1,50 x 0,59	4,50 x 4,42	0,59	3+	6
<b>FESTO LUMO</b>	IS-MM-002			2,00 x 2,00 x 0,80	5,00 x 5,00	0,8	3+	8



# The Lumo Board

is a new addition to the market, standing out with its unique design and functionality. It's the perfect combination of fun and sensory development for young children.

## Die LUMO Spieltafel

ist eine Neuheit auf dem Markt und zeichnet sich durch sein einzigartiges Design und seine Funktionalität aus. Es ist die perfekte Kombination aus Spielspaß und sensorischer Entwicklung für Kleinkinder.

### Sensory stimulation:

The board is equipped with rotating elements that light up, engaging a child's senses.

### Eye-catching graphics:

The themed, colorful design makes the board exceptionally attractive.

### Magical light effect:

The glowing circles create fascinating visual effects, enhancing the joy of play.

### Engaging challenge:

Children can try to light up all the circles at once, developing their motor skills and coordination.

### Sensorische Stimulation:

die Spieltafel ist mit drehbaren Elementen ausgestattet, die aufleuchten und die Sinne des Kindes ansprechen.

### Auffällige Grafiken:

Das thematische, bunte Design macht die Spieltafel besonders attraktiv.

### Magischer Lichteffekt:

Die leuchtenden Kreise erzeugen faszinierende visuelle Effekte und steigern die Freude am Spielen.

### Fesselnde Herausforderung:

Kinder können versuchen, alle Kreise gleichzeitig zum Leuchten zu bringen, wodurch ihre motorischen Fähigkeiten und die Koordination gefördert werden.





**FIREFIGHTER LUMO**  
01-TA-814-LP



**DIVER LUMO**  
01-TA-803-LP



**CASTLE LUMO**  
01-TA-813-LP



**GHOSTS 1 LUMO**  
01-TA-802-LP



**GHOSTS 2 LUMO**  
01-TA-812-LP



**ROCKET 1 LUMO**  
01-TA-800-LP



**ROCKET 2 LUMO**  
01-TA-810-LP



**ROCKET 3 LUMO**  
01-TA-811-LP



<b>FIREFIGHTER LUMO</b>	01-TA-814-LP	0,90 x 0,10 x 1,25	3,90 x 3,10	-	2+	2
<b>DIVER LUMO</b>	01-TA-803-LP	0,90 x 0,10 x 1,25	3,90 x 3,10	-	2+	2
<b>CASTLE LUMO</b>	01-TA-813-LP	0,90 x 0,10 x 1,25	3,90 x 3,10	-	2+	2
<b>GHOSTS 1 LUMO</b>	01-TA-802-LP	0,90 x 0,10 x 1,25	3,90 x 3,10	-	2+	2
<b>GHOSTS 2 LUMO</b>	01-TA-812-LP	0,90 x 0,10 x 1,25	3,90 x 3,10	-	2+	2
<b>ROCKET 1 LUMO</b>	01-TA-800-LP	0,90 x 0,10 x 1,25	3,90 x 3,10	-	2+	2
<b>ROCKET 2 LUMO</b>	01-TA-810-LP	0,90 x 0,10 x 1,25	3,90 x 3,10	-	2+	2
<b>ROCKET 3 LUMO</b>	01-TA-811-LP	0,90 x 0,10 x 1,25	3,90 x 3,10	-	2+	2



**SPIDER LUMO**  
01-TA-809-LP



**BEE LUMO**  
01-TA-808-LP



**FIREFLY LUMO**  
01-TA-801-LP

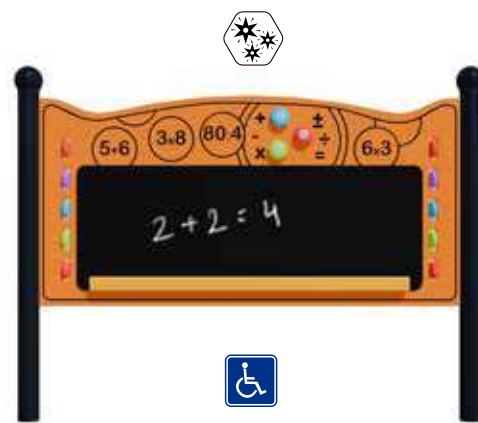

**DRAWING BOARD LUMO**  
01-TA-832-LP



								
<b>SPIDER LUMO</b>	01-TA-809-LP	0,90 x 0,10 x 1,25	3,90 x 3,10	-	2+	2		
<b>BEE LUMO</b>	01-TA-808-LP	0,90 x 0,10 x 1,25	3,90 x 3,10	-	2+	2		
<b>FIREFLY LUMO</b>	01-TA-801-LP	0,90 x 0,10 x 1,25	3,90 x 3,10	-	2+	2		
<b>DRAWING BOARD LUMO</b>	01-TA-832-LP	1,65 x 0,1 x 1,25	4,65 x 3,1	-	2+	4		

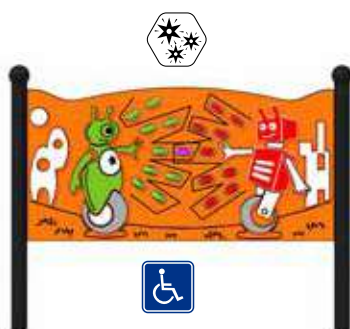

**ROBOTS 1 LUMO**  
01-TA-804-LP

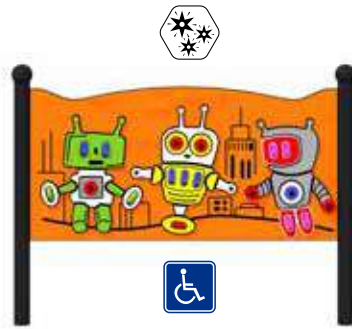

**ROBOTS 2 LUMO**  
01-TA-822-LP



**ROBOTS 3 LUMO**  
01-TA-823-LP



**DOGS LUMO**  
01-TA-821-LP



**CATS LUMO**  
01-TA-820-LP



**DINO LUMO**  
01-TA-806-LP



							
<b>ROBOTS 1 LUMO</b>	01-TA-804-LP	1,65 x 0,10 x 1,25	4,65 x 3,10	-	2+	4	
<b>ROBOTS 2 LUMO</b>	01-TA-822-LP	1,65 x 0,10 x 1,25	4,65 x 3,10	-	2+	4	
<b>ROBOTS 3 LUMO</b>	01-TA-823-LP	1,65 x 0,10 x 1,25	4,65 x 3,10	-	2+	4	
<b>DOGS LUMO</b>	01-TA-821-LP	1,65 x 0,10 x 1,25	4,65 x 3,10	-	2+	4	
<b>CATS LUMO</b>	01-TA-820-LP	1,65 x 0,10 x 1,25	4,65 x 3,10	-	2+	4	
<b>DINO LUMO</b>	01-TA-806-LP	1,65 x 0,10 x 1,25	4,65 x 3,10	-	2+	4	



**DRAGON 1 LUMO**  
01-TA-807-LP



**DRAGON 2 LUMO**  
01-TA-818-LP

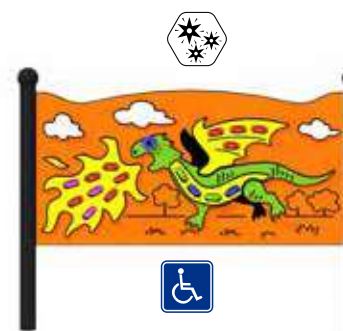

**DRAGON 3 LUMO**  
01-TA-819-LP





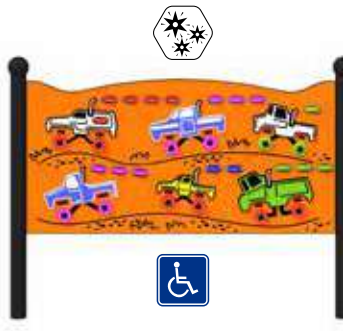

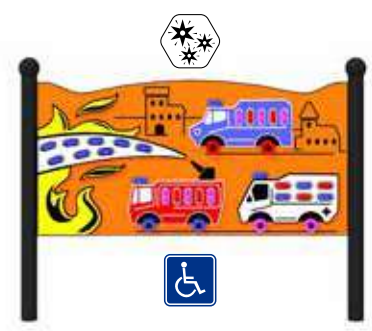

**CARS 1 LUMO**  
01-TA-805-LP



**CARS 2 LUMO**  
01-TA-816-LP



**CARS 3 LUMO**  
01-TA-817-LP

							
<b>DRAGON 1 LUMO</b>	01-TA-807-LP	1,65 x 0,10 x 1,25	4,65 x 3,10	-	2+	4	
<b>DRAGON 2 LUMO</b>	01-TA-818-LP	1,65 x 0,10 x 1,25	4,65 x 3,10	-	2+	4	
<b>DRAGON 3 LUMO</b>	01-TA-819-LP	1,65 x 0,10 x 1,25	4,65 x 3,10	-	2+	4	
<b>CARS 1 LUMO</b>	01-TA-805-LP	1,65 x 0,10 x 1,25	4,65 x 3,10	-	2+	4	
<b>CARS 2 LUMO</b>	01-TA-816-LP	1,65 x 0,10 x 1,25	4,65 x 3,10	-	2+	4	
<b>CARS 3 LUMO</b>	01-TA-817-LP	1,65 x 0,10 x 1,25	4,65 x 3,10	-	2+	4	



**WORLD OF VEHICLES 1 LUMO**  
01-TA-828-LP



**WORLD OF ANIMALS 1 LUMO**  
01-TA-831-LP



**WORLD OF DRAGONS 1 LUMO**  
01-TA-830-LP

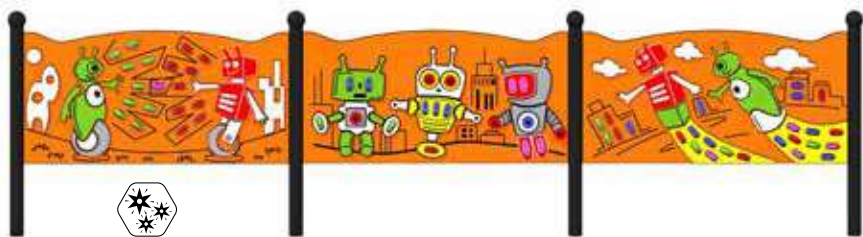

**WORLD OF ROBOTS 1 LUMO**  
01-TA-829-LP



Product Name	Code	Dimensions (L x W x H)	Length x Width	Height	Age Suitability	Pieces
WORLD OF VEHICLES 1 LUMO	01-TA-828-LP	4,80 x 0,10 x 1,25	7,80 x 3,10	-	2+	12
WORLD OF ANIMALS 1 LUMO	01-TA-831-LP	4,80 x 0,10 x 1,25	7,80 x 3,10	-	2+	12
WORLD OF DRAGONS 1 LUMO	01-TA-830-LP	4,80 x 0,10 x 1,25	7,80 x 3,10	-	2+	12
WORLD OF ROBOTS 1 LUMO	01-TA-829-LP	4,80 x 0,10 x 1,25	7,80 x 3,10	-	2+	12

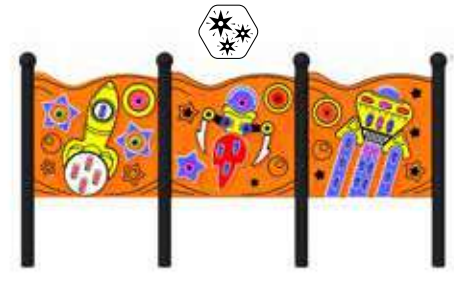

**WORLD OF STARS 1**  
01-TA-827-LP



**WORLD OF BUGS 1 LUMO**  
01-TA-826-LP



**WORLD OF STORIES 1 LUMO**  
01-TA-825-LP



**WORLD OF HEROES 1 LUMO**  
01-TA-824-LP



<b>WORLD OF STARS 1</b>	01-TA-827-LP	4,80 x 0,10 x 1,25	7,80 x 3,10	-	2+	12
<b>WORLD OF BUGS 1 LUMO</b>	01-TA-826-LP	4,80 x 0,10 x 1,25	7,80 x 3,10	-	2+	12
<b>WORLD OF STORIES 1 LUMO</b>	01-TA-825-LP	4,80 x 0,10 x 1,25	7,80 x 3,10	-	2+	12
<b>WORLD OF HEROES 1 LUMO</b>	01-TA-824-LP	4,80 x 0,10 x 1,25	7,80 x 3,10	-	2+	12

# SALTO





## Trampoline construction | Konstruktion des Trampolins

**Construction | Konstruktion**

The body of the trampoline is shaped like a chest. It is made of thick welded sheet metal, which provides stability and durability of the trampoline.

Die Konstruktion des Trampolins besteht aus einem geschweißtem, verzinktem Stahlrahmen. Das gewährleistet die richtige Stabilisierung und gewünschte Lebensdauer des Trampolins.

**Springs | Federn**

Springs are very durable and allow jumping by bending the mat. They have been made to last for years in public facilities.

Die hochqualitative Feder ermöglichen sanftes Springen, ohne ungewünschten Geräuschen. Die Feder wurden so konzipiert, dass sie für den langjährigen Einsatz in den öffentlichen Bereichen geeignet sind.

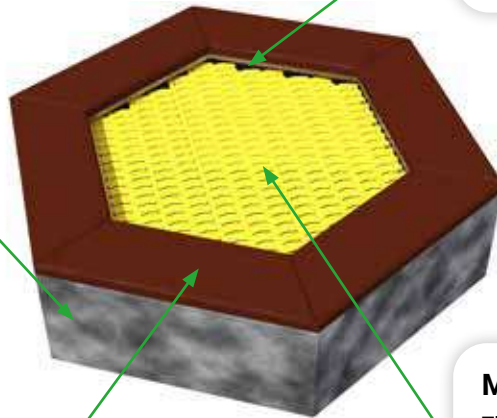
**Elastic collar | Fallschutzumrandung**

Provides security to user and protects against falling outside the jumping area.

Die integrierte, weiche Umrandung sorgt für die Sicherheit der Nutzer. Sie schützt vor den Verletzungen beim Herausfallen aus der Sprungfläche.

**Mat | Sprungmatte**

The jumping mat is made of very durable lamellas threaded on steel cables. The lamellas have been designed to be durable and reliable, their specific surface prevents slipping.

Die Sprungmatte wird aus langlebigen und wetterfesten Lamellen gefertigt, die auf Stahldrähten aufgefädelt sind. Die Lamellenform verhindert das Brechen. Ihre spezifische Oberfläche schützt vor dem Verrutschen.



Non-slip surface.

Rutschfeste Oberfläche.

The wide lamella wings provide greater comfort when jumping.

Die breiten Lamellenflügel sorgen für besseren Komfort beim Springen.

Very durable, thick and strong bushings with high resistance for exploitation.

Dicke, sehr starke und langlebige Buchsen mit hoher Verschleißfestigkeit.

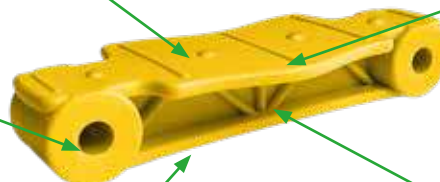

The lamellas are extremely durable thanks to specially designed reinforcements.

Die Lamellen sind dank speziell entwickelter Verstärkungen extrem langlebig.

Thanks to the unique shape of the lamellas, the space between them has been reduced to only 7 mm. This prevents small items such as keys or cell phones from falling inside the trampoline.

Dank der einzigartigen Form der Lamellen wurde der Innenabstand auf nur 7 mm reduziert. Dadurch wird verhindert, dass kleine Dinge wie Schlüssel oder Handys in das Trampolin fallen.

Trampoline construction | Konstruktion des Trampolins

**Construction | Konstruktion**

The Trampoline body is embedded directly in the ground. It is very stable and durable due to anti corrosion protection by hot - dip galvanizing.

Das Trampolin wird als ein Element in den Boden eingesetzt. Seine solide Konstruktion und Langlebigkeit verdankt es der Feuerverzinkung.

**Safe surface | Sicherheitsbereich**

There should be a safe surface around the trampoline to protect children from falls.

Um das Trampolin herum sollte ein sicherer Bodenbelag vorhanden sein, der die Kinder vor Sturzfolgen schützt.

**Hardened ground | Befestigter Untergrund**

The trampoline is directly mounted on the hardened and levelled ground, which needs to be permeable to water.

Das Trampolin soll direkt auf den befestigten, stabilen Untergrund gesetzt werden. Der Untergrund muss wasserdurchlässig sein.

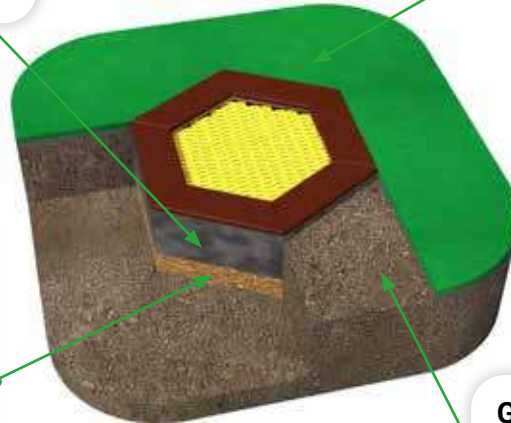

**Ground | Boden**

The trampoline is installed in the ground at a depth of 40 cm.

Das Trampolin soll in eine Grubentiefe von 40 cm eingesetzt werden.

Cleaning the inside of the trampoline | Reinigung des Inneraums

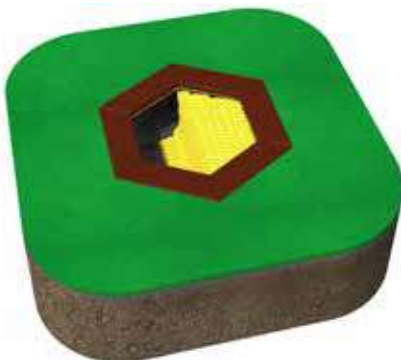

**Variant I - removing the mat**

**Variante I - Entfernung der Sprungmatte**

To clean the trampoline you need to remove part of the jumping mat. Removing the mat is simple and involves sliding the rope shackles from the springs located along the perimeter of the body of the trampoline.

Um das Trampolin zu reinigen, muss man ein Teil der Sprungmatte entfernen. Um die Sprungmatte zu entfernen, sollen die Seilschäkel von den Federn weggeschoben werden. Die Federn befinden sich auf dem Umfang der Konstruktion.

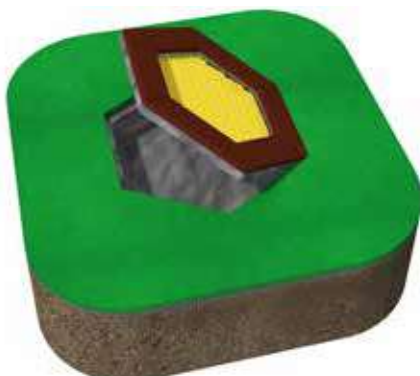

**Variant II - opening the cover**

**Variante II - Eröffnung des Hebedeckels**

Once you open the cover of the trampoline, you can simply clean its inside.

Das Trampolin kann auch durch die einfache Eröffnung von Hebedeckels gereinigt werden.

## The colours of the lamellas | Lamellenfarben

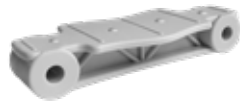
black | schwarz  
RAL 9005gray | grau  
RAL 7035green | grün  
RAL 6029red | rot  
RAL 3020blue | blau  
RAL 5005pastel blue | pastellblau  
RAL 5024yellow | gelb  
RAL 1018orange | orange  
RAL 2005

## Patterns on the jumping mat | Sprungmattenmotive

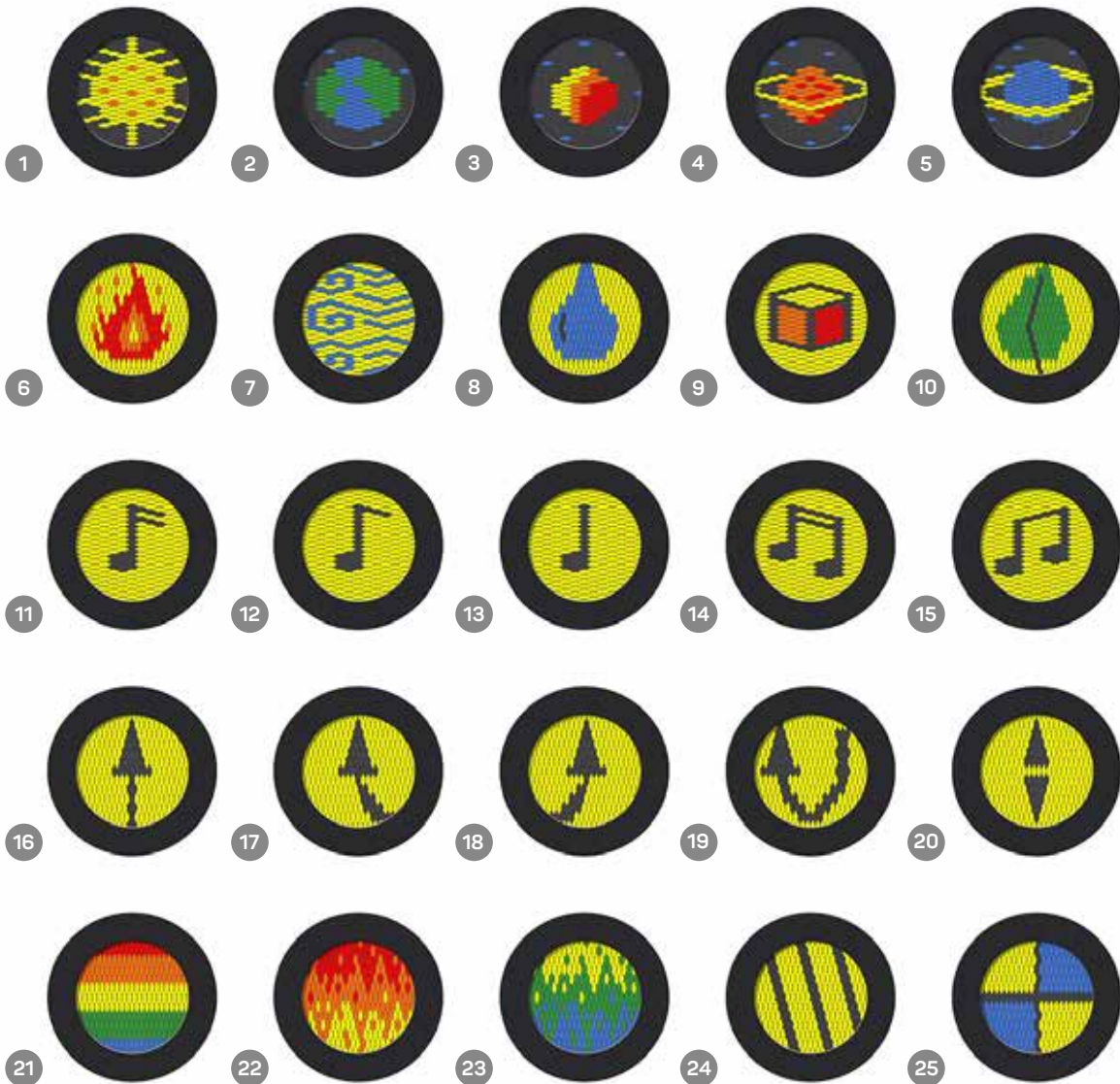

Elastic collar colours | Farben Umrandungsfarben

SBR



red  
rot

black  
schwarz

EPDM

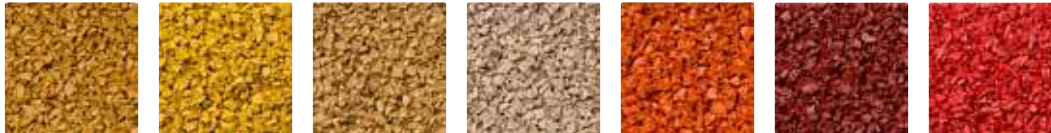

1002  
sand yellow  
sandgelb

1012  
yellow  
gelb

1014  
ivory  
elfenbein

1015  
light ivory  
creme

2008  
orange  
orange

3016  
red  
rot

3017  
rose  
rose



4003  
heather violet  
violett

4005  
blue lilac  
blau lila

5010  
gentian blue  
blau

5012  
light blue  
hellblau

5015  
sky blue  
himmelblau

6005  
moss green  
mossegrün

6011  
reseda green  
erbsengrün

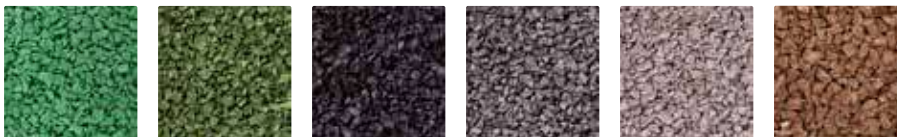

6017  
may green  
maigrün

6021  
pale green  
hellgrün

7011  
iron grey  
schiefergrau

7037  
dusty grey  
grau

7038  
agate grey  
lichtgrau

8024  
beige brown  
beige braun



8025  
pale brown  
braun

9004  
black  
schwarz

9010  
pure white  
weiß

DESIGN YOUR TRAMPOLINE | GESTALTEN SIE IHR TRAMPOLIN

Create your own unique trampoline - choose a color, pattern, shape and size.

Erstellen Sie Ihr eigenes einzigartiges Trampolin - wählen Sie Farbe, Muster, Form und Größe aus.



# TRAMPOLINE

## DESIGN STUDIO

Create your unique design on the trampoline.  
Based on your project, we will make  
a trampoline for you.

Erstellen Sie Ihr einzigartiges Design für das  
Trampolin. Basierend auf Ihrem Projekt werden  
wir ein Trampolin für Sie anfertigen.

1



Choose trampoline parameters  
(shape, size, collar color)

Wählen Sie die Trampolinparameter  
(Form, Größe, Farbe des Kragens)

2



Create a unique, custom  
trampoline design.

Erstellen Sie ein einzigartiges,  
individuelles Trampolin-  
Design.

3



Receive your design at the provided email ad-  
dress. You can order the trampoline production  
from us.

Erhalten Sie Ihr Design an die angegebene E-Mail-  
Adresse. Sie können bei uns die Herstellung des  
Trampolins bestellen.

Visit our app

Besuchen Sie unsere App

[tdesign-studio.com](https://tdesign-studio.com)



„Now with AI image creation  
support“

„Jetzt mit Unterstützung von  
KI-Bilderstellung“

Do you want a trampoline that captivates with its unique design? Discover the Trampoline Design Studio - an innovative tool that allows you to create a trampoline mat with your own one-of-a-kind pattern.

Träumst du von einem Trampolin, das mit seinem einzigartigen Design beeindruckt? Entdecke das Trampolin Design Studio - ein innovatives Online-Werkzeug, das die Erstellung der Trampolinmatte mit eigenem, einzigartigem Muster ermöglicht.

Possibility to save the project file and return to work on it later.  
Möglichkeit, die Projektdatei zu speichern und später weiter daran zu arbeiten.

Choose from various sizes and shapes of trampolines.  
Wählen Sie aus verschiedenen Größen und Formen von Trampolinen.

The design of the trampoline is limited only by your imagination.  
Das Trampolinmuster ist nur durch Ihre Vorstellungskraft begrenzt.

Wide selection of trampoline lamellas and collar colors.  
Große Auswahl an Farben für Lamellen und Trampolinrand.

Visit our app  
Besuchen Sie unsere App   
**[tdesign-studio.com](https://tdesign-studio.com)**

See the unique designs created with the Trampoline Design Studio.

Sehen Sie sich die einzigartigen Designs an, die mit dem Trampoline Design Studio erstellt wurden.



The Trampoline Design Studio is easy to use and intuitive, making it simple to transform a standard trampoline into a distinctive play element.

Das Trampolin Design Studio ist einfach und intuitiv zu bedienen, ermöglicht leicht ein Standardtrampolin in ein einzigartiges Spielelement zu verwandeln.

**SALTO trampoline without an elastic collar are adapted to be covered with a safe surface.**

Salto Trampolin ohne elastische Umrandung für den fugenlosen Fallschutzbelag.

**1** Trampoline without elastic collar ready for surface installation.

Trampolin ohne Fallschutz ist für die Anwendung des fugenlosen Fallschutzbelages bereit.

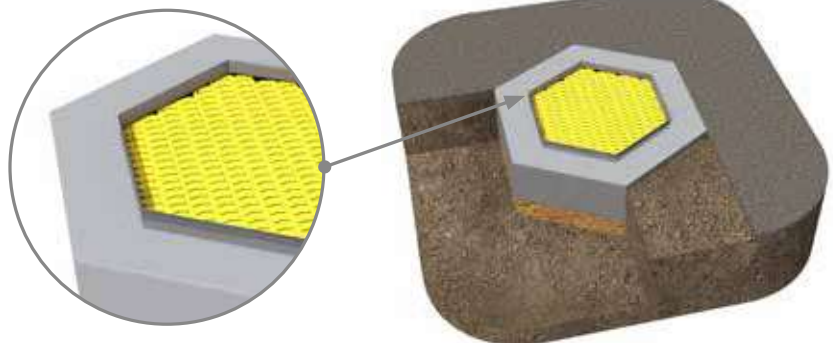

**2** Installation of a safe surface using a formwork strip.

Der Ausguß des fugenlosen Fallschutzbelages (vergessen Sie die Schalungsleiste nicht!).

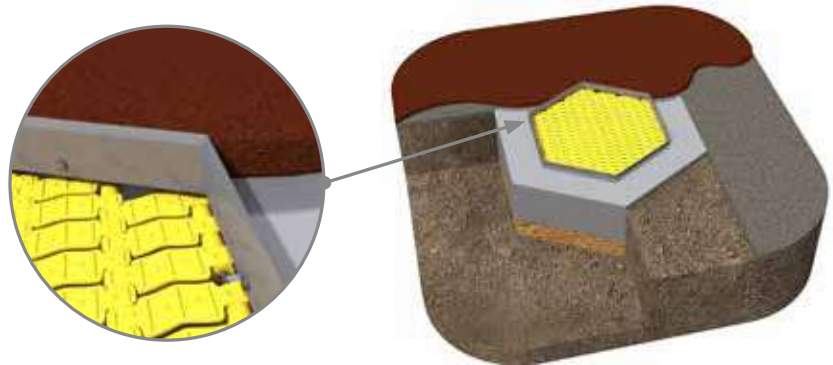

**3** The safe surface before removing the formwork strip.

Fertiger Fallschutzbelag vor der Entfernung der Schalungsleiste.

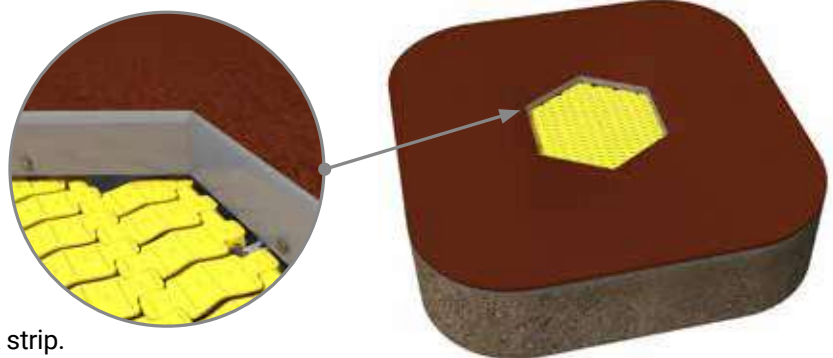

**4** Unscrewing and removing the formwork strip.

Die Schalungsleiste kann erst jetzt abgeschraubt und demontiert werden.



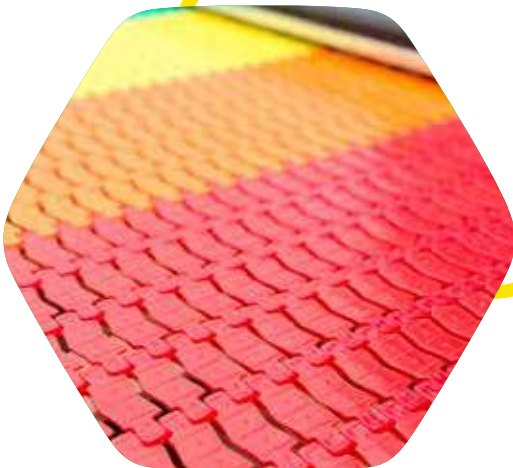

## Types of trampolines | Trampolin Arten

## Trampoline PAKO



NAME	CODE	A - DIMENSION	B - JUMPING AREA	C - SAFETY AREA
		A - TRAMPOLINGRÖSSE	B - SPRUNGMATTE	C - SICHERHEITSRAUM
PAKO 125	MA-SA-21	1,25 x 1,25 m	0,75 x 0,75 m	3,75 x 3,75 m
PAKO 150	MA-SA-22	1,5 x 1,5 m	1,0 x 1,0 m	4,0 x 4,0 m
PAKO 175	MA-SA-23	1,75 x 1,75 m	1,25 x 1,25 m	5,25 x 5,25 m
PAKO 200	MA-SA-24	2,0 x 2,0 m	1,5 x 1,5 m	5,5 x 5,5 m
PAKO 225	MA-SA-25	2,25 x 2,25 m	1,75 x 1,75 m	5,75 x 5,75 m
PAKO 250	MA-SA-26	2,5 x 2,5 m	2,0 x 2,0 m	6,0 x 6,0 m

## Trampoline RADO



NAME	CODE	A - DIMENSION	B - JUMPING AREA	C - SAFETY AREA
		A - TRAMPOLINGRÖSSE	B - SPRUNGMATTE	C - SICHERHEITSRAUM
RADO 125	MA-SA-01	Ø 1,25 m	Ø 0,75 m	Ø 3,75 m
RADO 140	MA-SA-02	Ø 1,4 m	Ø 0,9 m	Ø 3,9 m
RADO 150	MA-SA-03	Ø 1,5 m	Ø 1,0 m	Ø 4,0 m
RADO 160	MA-SA-04	Ø 1,6 m	Ø 1,1 m	Ø 4,1 m
RADO 175	MA-SA-05	Ø 1,75 m	Ø 1,25 m	Ø 4,25 m
RADO 200	MA-SA-06	Ø 2,0 m	Ø 1,5 m	Ø 5,5 m
RADO 225	MA-SA-07	Ø 2,25 m	Ø 1,75 m	Ø 5,75 m

## Trampoline ORTA



NAME	CODE	A - DIMENSION	B - JUMPING AREA	C - SAFETY AREA
		A - TRAMPOLINGRÖSSE	B - SPRUNGMATTE	C - SICHERHEITSRAUM
ORTA 125 X 225	MA-SA-40	1,25 x 2,25 m	0,75 x 1,75 m	3,75 x 4,75 m
ORTA 150 X 200	MA-SA-41	1,5 x 2,0 m	1,0 x 1,5 m	5,0 x 5,5 m
ORTA 150 X 225	MA-SA-42	1,5 x 2,25 m	1,0 x 1,75 m	5,0 x 5,75 m
ORTA 150 X 250	MA-SA-43	1,5 x 2,5 m	1,0 x 2,0 m	5,0 x 6,0 m
ORTA 175 X 225	MA-SA-44	1,75 x 2,25 m	1,25 x 1,75 m	5,25 x 5,75 m
ORTA 175 X 250	MA-SA-45	1,75 x 2,5 m	1,25 x 2,0 m	5,25 x 6,0 m
ORTA 150 X 300	MA-SA-46	1,5 x 3,0 m	1,0 x 2,5 m	5,0 x 6,5 m
ORTA 150 x 900	MA-SA-48	1,5 x 9,0 m	1,0 x 8,5 m	5,0 x 12,25 m

## Trampoline ORTA-I



integrado



NAME	CODE	A - DIMENSION	B - JUMPING AREA	C - SAFETY AREA
		A - TRAMPOLINGRÖSSE	B - SPRUNGMATTE	C - SICHERHEITSRAUM
ORTA-I 150 X 200	MA-SA-41-I	1,5 x 2,0 m	1,0 x 1,5 m	5,0 x 5,5 m
ORTA-I 150 X 250	MA-SA-43-I	1,5 x 2,5 m	1,0 x 2,0 m	5,0 x 6,0 m
ORTA-I 150 X 300	MA-SA-46-I	1,5 x 3,0 m	1,0 x 2,5 m	5,0 x 6,5 m
ORTA-I 150 X 500	MA-SA-47-I	1,5 x 5,0 m	1,0 x 4,5 m	5,0 x 8,5 m
ORTA-I 150 x 900	MA-SA-48-I	1,5 x 9,0 m	1,0 x 8,25 m	5,0 x 12,25 m

**A** - trampoline dimension

Trampolingröße

**B** - the size of the jumping mat

Größe der Sprungmatte

**C** - safety area

Sicherheitsraum

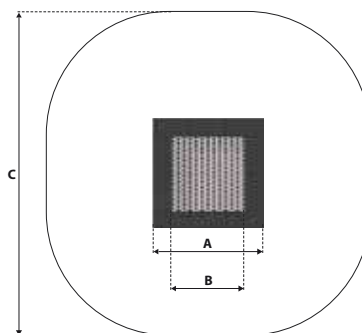

Trampoline **HEXO**



NAME	CODE	A - DIMENSION	B - JUMPING AREA	C - SAFETY AREA
		A - TRAMPOLINGRÖSSE	B - SPRUNGMATTE	C - SICHERHEITSRAUM
HEXO 1	MA-SA-61	1,7 x 1,47 m	1,14 x 0,97 m	4,14 x 3,97 m

Trampoline **PENTO**



NAME	CODE	A - DIMENSION	B - JUMPING AREA	C - SAFETY AREA
		A - TRAMPOLINGRÖSSE	B - SPRUNGMATTE	C - SICHERHEITSRAUM
PENTO 1	MA-SA-51	1,68 x 1,6 m	1,18 x 1,5 m	4,68 x 4,6 m

Trampoline **KVARTALO**



NAME	CODE	A - DIMENSION	B - JUMPING AREA	C - SAFETY AREA
		A - TRAMPOLINGRÖSSE	B - SPRUNGMATTE	C - SICHERHEITSRAUM
KVARTALO 125	MA-SA-71	1,25 x 1,25 m	0,75 x 0,75 m	3,75 x 3,75 m
KVARTALO 150	MA-SA-72	1,5 x 1,5 m	1,0 x 1,0 m	4,0 x 4,0 m
KVARTALO 175	MA-SA-73	1,75 x 1,75 m	1,25 x 1,25 m	5,25 x 5,25 m
KVARTALO 200	MA-SA-74	2,0 x 2,0 m	1,5 x 1,5 m	5,5 x 5,5 m
KVARTALO 225	MA-SA-75	2,25 x 2,25 m	1,75 x 1,75 m	5,75 x 5,75 m
KVARTALO 250	MA-SA-76	2,5 x 2,5 m	2,0 x 1,0 m	6,0 x 6,0 m

Trampoline **JUNTO**



NAME	CODE	A - DIMENSION	B - JUMPING AREA	C - SAFETY AREA
		A - TRAMPOLINGRÖSSE	B - SPRUNGMATTE	C - SICHERHEITSRAUM
JUNTO 150 x 225	MA-SA-93	1,5 x 2,25 m	1,0 x 1,75 m	4,0 x 4,75 m

Trampoline **DIAMOND**



NAME	CODE	A - DIMENSION	B - JUMPING AREA	C - SAFETY AREA
		A - TRAMPOLINGRÖSSE	B - SPRUNGMATTE	C - SICHERHEITSRAUM
DIAMOND	MA-SA-52	2,37 x 1,3 m	1,55x 0,8 m	4,55 x 3,8



**HEXO 6A**  
MA-SA-67



**HEXO 4A**  
MA-SA-64



**HEXO 3A**  
MA-SA-62









**HEXO 3B**  
MA-SA-63



**HEXO 5A**  
MA-SA-66



**HEXO 4B**  
MA-SA-65

						
<b>HEXO 6A</b>	MA-SA-67	4,25 x 4,41	6,67 x 6,91	0,90	3+	6
<b>HEXO 4A</b>	MA-SA-64	4,25 x 4,41	6,91 x 6,67	0,90	3+	4
<b>HEXO 3A</b>	MA-SA-62	1,70 x 4,41	4,12 x 6,91	0,90	3+	3
<b>HEXO 3B</b>	MA-SA-63	2,94 x 2,97	5,44 x 5,39	0,90	3+	3
<b>HEXO 5A</b>	MA-SA-66	4,25 x 2,94	6,67 x 5,44	0,90	3+	5
<b>HEXO 4B</b>	MA-SA-65	4,25 x 3,68	6,67 x 6,18	0,90	3+	4
<b>HEXO 13A</b>	MA-SA-69	6,80 x 7,36	9,22 x 9,86	0,90	3+	13
<b>HEXO 7A</b>	MA-SA-68	4,25 x 4,42	6,67 x 6,91	0,90	3+	7



**HEXO 13A**  
MA-SA-69



**HEXO 7A**  
MA-SA-68





**TUTO 1**  
MA-SA-101



**TUTO 2**  
MA-SA-102



**TUTO 3**  
MA-SA-103



**TUTO 4**  
MA-SA-104



**TUTO 5**  
MA-SA-105



**TUTO 6**  
MA-SA-106



<b>TUTO 1</b>	MA-SA-101	1,75 x 4,65	4,25 x 7,15	0,90	3+	3
<b>TUTO 2</b>	MA-SA-102	3,81 x 4,20	6,69 x 6,30	0,90	3+	4
<b>TUTO 3</b>	MA-SA-103	2,97 x 3,20	5,47 x 5,69	0,90	3+	3
<b>TUTO 4</b>	MA-SA-104	3,91 x 3,91	5,42 x 5,42	0,90	3+	5
<b>TUTO 5</b>	MA-SA-105	1,25 x 3,75	3,75 x 6,25	0,90	3+	3
<b>TUTO 6</b>	MA-SA-106	3,00 x 3,00	5,50 x 5,50	0,90	3+	4
<b>TUTO 7</b>	MA-SA-107	4,00 x 4,00	6,50 x 6,50	0,90	3+	5
<b>TUTO 8</b>	MA-SA-108	1,75 x 8,04	4,75 x 11,05	0,90	3+	5
<b>TUTO 9</b>	MA-SA-109	2,12 x 5,65	4,05 x 7,95	0,90	3+	3



**TUTO 7**  
MA-SA-107









**TUTO 8**  
MA-SA-108



**TUTO 9**  
MA-SA-109





						
<b>TUTO 10</b>	MA-SA-110	2,25 x 8,00	4,75 x 10,50	0,90	3+	6
<b>TUTO 11</b>	MA-SA-111	3,00 x 4,50	5,50 x 7,00	0,90	3+	6
<b>TUTO 12</b>	MA-SA-112	4,50 x 4,50	7,00 x 7,00	0,90	3+	9
<b>TUTO 13</b>	MA-SA-113	3,00 x 3,00	5,50 x 5,50	0,90	3+	4
<b>TUTO 14</b>	MA-SA-114	3,50 x 3,50	6,00 x 6,00	0,90	3+	4
<b>TUTO 15</b>	MA-SA-115	3,00 x 6,00	5,50 x 8,50	0,90	3+	8
<b>TUTO 16</b>	MA-SA-116	3,00 x 4,50	5,50 x 7,00	0,90	3+	6
<b>TUTO 17</b>	MA-SA-117	3,00 x 3,00	5,50 x 5,50	0,90	3+	4
<b>TUTO 18</b>	MA-SA-118	3,00 x 6,00	5,50 x 8,50	0,90	3+	6



**TUTO 10**  
MA-SA-110



**TUTO 11**  
MA-SA-111



**TUTO 12**  
MA-SA-112



**TUTO 13**  
MA-SA-113



**TUTO 14**  
MA-SA-114



**TUTO 15**  
MA-SA-115



**TUTO 16**  
MA-SA-116



**TUTO 17**  
MA-SA-117



**TUTO 18**  
MA-SA-118



**TUTO 19**  
MA-SA-119



**TUTO 20**  
MA-SA-120



**TUTO 21**  
MA-SA-121



**TUTO 22**  
MA-SA-122



**TUTO 23**  
MA-SA-123



**TUTO 24**  
MA-SA-124



**TUTO 25**  
MA-SA-125



**TUTO 26**  
MA-SA-126



**TUTO 27**  
MA-SA-127



<b>TUTO 19</b>	MA-SA-119	3,00 x 7,50	5,50 x 10,00	0,90	3+	8
<b>TUTO 20</b>	MA-SA-120	6,00 x 7,50	8,50 x 10,00	0,90	3+	10
<b>TUTO 21</b>	MA-SA-121	4,50 x 9,00	7,00 x 11,50	0,90	3+	10
<b>TUTO 22</b>	MA-SA-122	4,50 x 4,50	7,00 x 7,00	0,90	3+	8
<b>TUTO 23</b>	MA-SA-123	7,50 x 7,50	10,00 x 10,00	0,90	3+	15
<b>TUTO 24</b>	MA-SA-124	9,00 x 9,00	11,50 x 11,50	0,90	3+	20
<b>TUTO 25</b>	MA-SA-125	10,50 x 10,50	13,00 x 13,00	0,90	3+	27
<b>TUTO 26</b>	MA-SA-126	7,50 x 10,50	10,00 x 13,00	0,90	3+	25
<b>TUTO 27</b>	MA-SA-127	10,50 x 10,50	13,00 x 13,00	0,90	3+	33





**TUTO 28**  
MA-SA-128



**TUTO 29**  
MA-SA-129



**TUTO 30**  
MA-SA-130



**TUTO 31**  
MA-SA-131



**TUTO 32**  
MA-SA-132

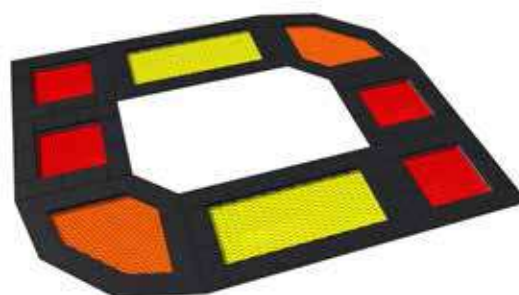

**TUTO 33**  
MA-SA-133



<b>TUTO 28</b>	MA-SA-128	11,70 x 3,38	13,99 x 5,88	0,90	3+	10
<b>TUTO 29</b>	MA-SA-129	10,50 x 4,50	13,00 x 6,93	0,90	3+	11
<b>TUTO 30</b>	MA-SA-130	10,50 x 3,00	13,00 x 5,44	0,90	3+	11
<b>TUTO 31</b>	MA-SA-131	7,50 x 3,00	10,00 x 5,50	0,90	3+	7
<b>TUTO 32</b>	MA-SA-132	3,2 x 3,2 m	5,7 x 5,7 m	0,9	3+	4
<b>TUTO 33</b>	MA-SA-133	5,17 x 4,17	7,67 x 6,67 m	0,9	3+	8



# integrado





## SAFETY SYSTEM

1 — 2 — 3 — 4 — 5

Swing | Schaukel

**SATURN**

1

Shock absorber prevents from excessive swinging of the gondola.

Der Stoßdämpfer verhindert übermäßiges Schwingen der Gondel.

2

Locking rim prevents the ramp from opening during swinging.

Das Verriegelungsband blockiert die Rampeneröffnung während des Schwingens.

3

Gondola's stabilizer makes entry of wheelchair users easier.

Der Stabilisator erleichtert die Einfahrt für Rollstuhlfahrer.

5

„Lock system” immobilizes the gondola and prevents the swing from use of unauthorized persons.

„Lock system” schützt vor der unbefugten Verwendung.

4

Rubber bumpers protects persons being in safety zone.

Weiche Stoßstangen schützen die sich an die Gondelbewegungszone annähernde Personen vom Verletzungen.



Skid-shaped gondola's stabilizer making easier entry for wheelchair

Das Stabilisierungsgestell für die Rollstuhlfahrer.



„Lock system” immobilizes the gondola and prevents the swing from use of unauthorized persons.

„Lock system” der vor der unbefugten Schaukelbenutzung schützt.





**SATURN**  
GM1611



**SATURN XXL**  
GM1612



For electric wheelchair  
Für elektrischen Rollstuhl



<b>SATURN</b>	GM1611	1,89 x 2,87 x 2,66	7,00 x 2,55	1,13	1+	1
<b>SATURN XXL</b>	GM1612	1,98 x 3,70 x 2,71	7,00 x 3,00	1,13	1+	1

1

When the gates are opened the roundabout is immobilized. Rotation is only possible if all gates are closed.

Wenn die Pforten geöffnet sind, ist das Karussell blockiert und dreht sich nicht. Das Drehen ist erst möglich, wenn alle Tore geschlossen sind.

## SAFETY SYSTEM

1 — 2 — 3 — 4

Inclusive roundabout | Inklusive Karussell

**YUGO**

4

Opening the gate while the roundabout rotates causes the device to slow down and stop.

Das Öffnen der Pforten während sich das Karussell dreht, verursacht eine automatische Ausbremsung bis zum Anhalten.

2

The centrifugal brake prevents the roundabout from rotating too quickly.

Eine Fliehkraftbremse verhindert zu schnelle Drehung.

3

Turning the handle allows to open the gate.

Das Tor öffnet sich, wenn die Knöpfe gedreht werden.

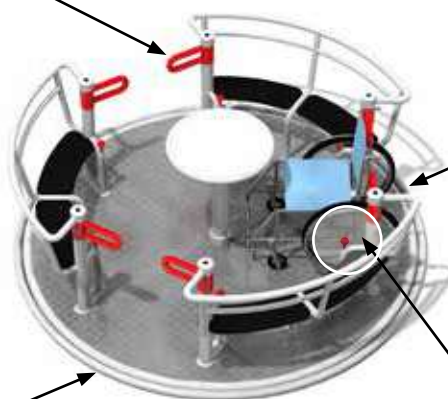



**YUGO 2**  
GM0622

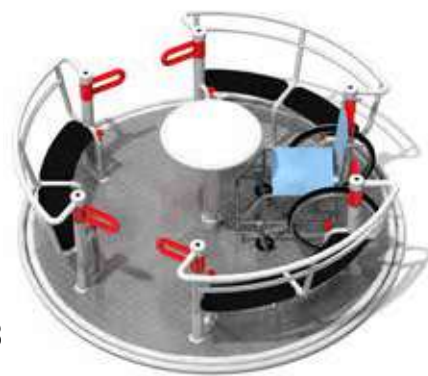

**YUGO 3**  
GM0621

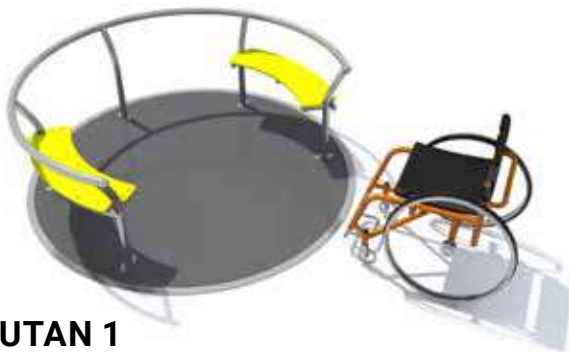

**AUTAN 1**  
IS-IN-101



**AUTAN 2**  
IS-IN-102





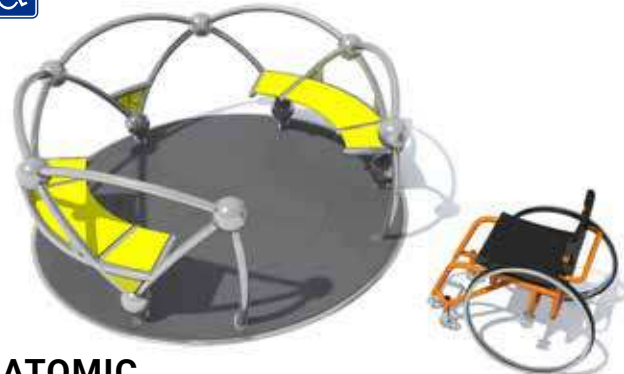



**AUTAN 3**  
IS-IN-103



**ATOMIC**  
IS-IN-111



							
<b>YUGO 2</b>	GM0622	2,20 x 2,20 x 0,79	6,20 x 6,20	1,00	3+	6	
<b>YUGO 3</b>	GM0621	2,47 x 2,47 x 0,79	6,47 x 6,47	1,00	3+	9	
<b>AUTAN 1</b>	IS-IN-101	1,89 x 1,89 x 0,63	5,89 x 5,89	1,00	3+	5	
<b>AUTAN 2</b>	IS-IN-102	2,13 x 2,13 x 0,71	6,14 x 6,14	1,00	3+	5	
<b>AUTAN 3</b>	IS-IN-103	2,14 x 2,14 x 1,00	6,14 x 6,14	1,00	3+	4	
<b>ATOMIC</b>	IS-IN-111	2,14 x 2,14 x 0,83	6,14 x 6,14	1,00	3+	9	

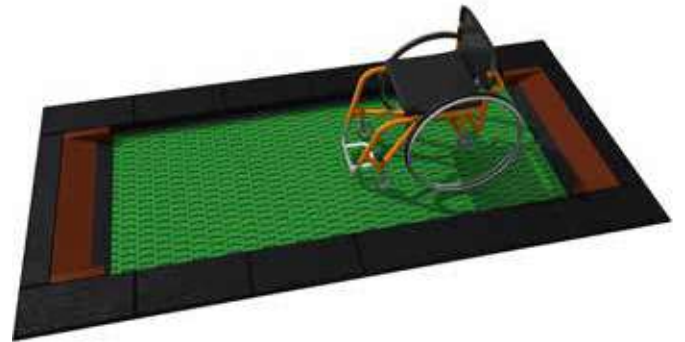

**ORTA-I 150 X 250**

MA-SA-43-I



**FESTO MINI LUMO**

IS-MM-001



**FESTO LUMO**

IS-MM-002



<b>ORTA-I 150 X 200</b>	MA-SA-41-I	1,50 x 2,00	4,00 x 4,25	0,90	3+	1
<b>ORTA-I 150 X 250</b>	MA-SA-43-I	1,50 x 2,50	5,00 x 5,75	0,90	3+	2
<b>ORTA-I 150 X 300</b>	MA-SA-46-I	1,50 x 3,00	5,00 x 6,25	0,90	3+	2
<b>ORTA-I 150 X 500</b>	MA-SA-47-I	1,50 x 5,00	5,00 x 8,25	0,90	3+	4
<b>FESTO MINI LUMO</b>	IS-MM-001	1,42 x 1,50 x 0,59	4,50 x 4,42	0,59	3+	6
<b>FESTO LUMO</b>	IS-MM-002	2,00 x 2,00 x 0,80	5,00 x 5,00	0,8	3+	8

**SOMERO 1**  
CT-IN-01

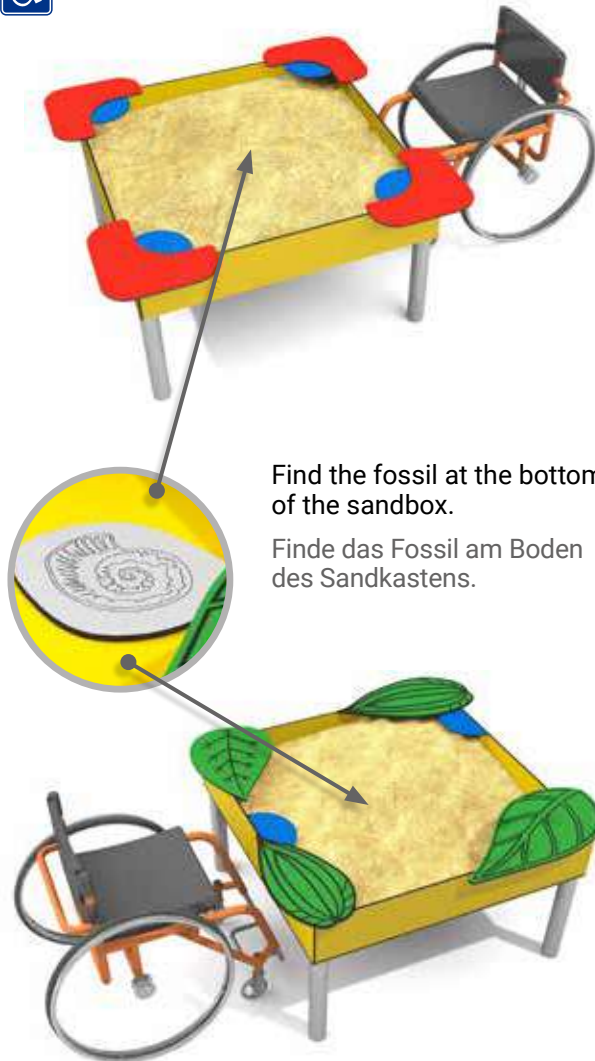

Find the fossil at the bottom of the sandbox.  
Finde das Fossil am Boden des Sandkastens.

**SOMERO 3**  
CT-IN-03

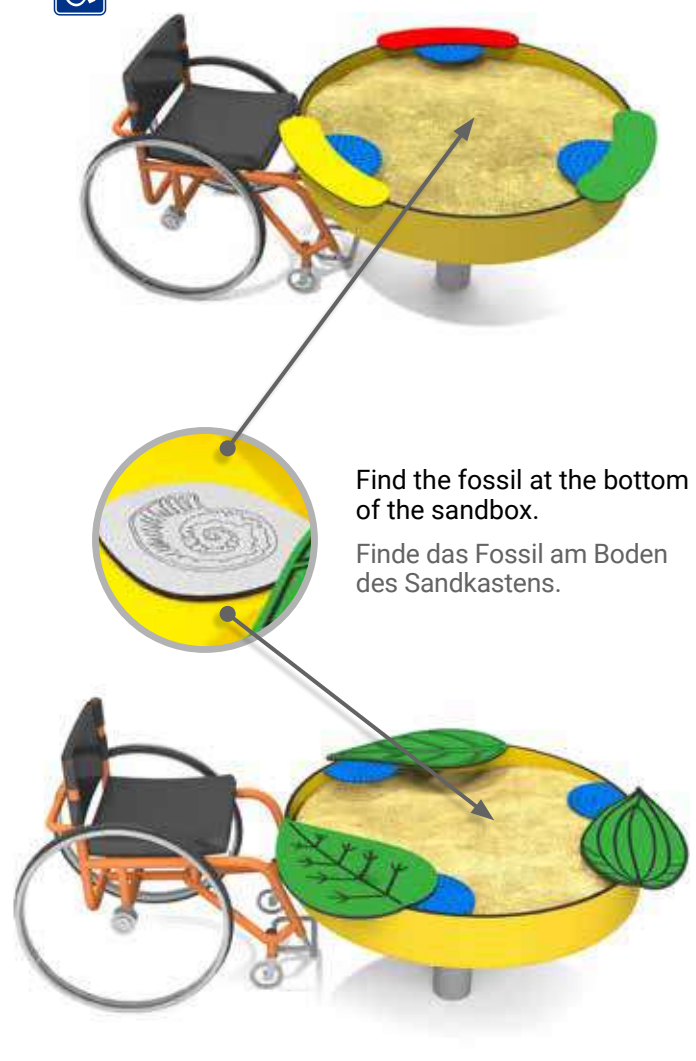

Find the fossil at the bottom of the sandbox.  
Finde das Fossil am Boden des Sandkastens.

**SOMERO 2**  
CT-IN-02



**SOMERO 4**  
CT-IN-04



<b>SOMERO 1</b>	CT-IN-01	1,20 x 1,18 x 0,95	4,20 x 4,18	-	3+	4	
<b>SOMERO 2</b>	CT-IN-02	1,17 x 1,14 x 0,95	4,17 x 4,14	-	3+	4	
<b>SOMERO 3</b>	CT-IN-03	1,40 x 1,40 x 0,95	4,40 x 4,40	-	3+	3	
<b>SOMERO 4</b>	CT-IN-04	1,21 x 1,21 x 0,95	4,21 x 4,21	-	3+	3	



**KOTO 1A**  
CT-IN-05



**KOTO 1B**  
CT-IN-06



Mix sand  
Gib dem Sand



with water  
das Wasser zu



and play with it.  
und spiele damit.



**KOTO 2A**  
CT-IN-07



**KOTO 2B**  
CT-IN-08



<b>KOTO 1A</b>	CT-IN-05	1,19 x 1,18 x 0,95	4,19 x 4,18	-	3+	4
<b>KOTO 1B</b>	CT-IN-06	1,26 x 1,22 x 0,95	4,26 x 4,22	-	3+	4
<b>KOTO 2A</b>	CT-IN-07	2,19 x 1,18 x 0,95	5,19 x 4,18	-	3+	6
<b>KOTO 2B</b>	CT-IN-08	2,20 x 1,25 x 0,95	5,20 x 4,25	-	3+	6
<b>KOTO 3A</b>	CT-IN-09	3,20 x 1,18 x 0,95	6,20 x 4,18	-	3+	8
<b>KOTO 3B</b>	CT-IN-10	3,19 x 1,30 x 0,90	6,19 x 4,30	-	3+	8
<b>KOTO 4A</b>	CT-IN-11	2,19 x 2,18 x 0,95	5,19 x 5,18	-	3+	8
<b>KOTO 4B</b>	CT-IN-12	2,34 x 2,31 x 0,95	5,34 x 5,31	-	3+	8





**KOTO 3A**  
CT-IN-09



**KOTO 3B**  
CT-IN-10



Mix sand  with water  and play with it.   
 Gib dem Sand das Wasser zu and spiele damit.



**KOTO 4A**  
CT-IN-11



**KOTO 4B**  
CT-IN-12





**POGO**  
K305



**MERCURY**  
IS-IN-302



**STANDING FRAME 2**  
GK-IN-303



**MIKSI**  
IS-IN-301S



**LIBELO**  
IS-IN-201



**DIGO-I**  
KS-IN-01



<b>POGO</b>	K305	3,47 x 0,75 x 2,77	2,16 x 7,80	1,30	1+	2
<b>MERCURY</b>	IS-IN-302	2,65 x 1,84 x 2,29	1,75 x 7,35	1,34	1+	1
<b>MIKSI</b>	IS-IN-301S	7,54 x 2,25 x 2,52	6,89 x 7,80	1,30	3+	4
<b>DIGO-I</b>	KS-IN-01	1,12 x 0,38 x 0,88	5,20 x 5,20	1,00	3+	1
<b>LIBELO</b>	IS-IN-201	2,38 x 0,71 x 1,31	5,38 x 3,71	0,98	3+	3
<b>STANDING FRAME 2</b>	GK-IN-303	2,43 x 2,06 x 2,10	5,43 x 5,06	1,97	6+	4
<b>STANDING FRAME 1</b>	GK-IN-302	0,87 x 0,08 x 2,10	3,87 x 3,08	1,97	6+	1





**KAJO 1**  
K1001



**KAJO 2**  
K1002

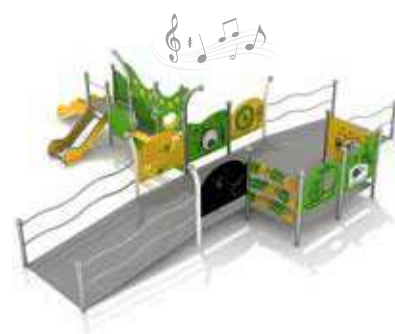

**KAJO 3**  
K1003









**CENTAUR**  
GK-IN-495503



**DRAGON**  
GK-IN-495506



								
<b>KAJO 1</b>	K1001			6,36 x 3,22 x 2,25	9,36 x 6,22	0,55	3+	11
<b>KAJO 2</b>	K1002			8,91 x 6,39 x 2,25	11,82 x 9,38	0,55	3+	14
<b>KAJO 3</b>	K1003			6,36 x 6,91 x 2,24	9,91 x 9,36	0,59	3+	16
<b>CENTAUR</b>	GK-IN-495503			9,17 x 7,37 x 2,30	10,49 x 12,46	1,20	3+	21
<b>DRAGON</b>	GK-IN-495506			14,61 x 11,99 x 3,16	18,14 x 15,20	2,00	3+	37





**INFANO-I 4**  
K754-I



**INFANO-I 5**  
K755-I



**INFANO-I 6**  
K756-I



**DOMETO-I 1-1**  
K511-I



**INFANO-I 4**

K754-I

6,07 x 2,84 x 2,49

9,07 x 6,34

0,59

1+

9

**INFANO-I 5**

K755-I

6,07 x 3,59 x 2,49

9,07 x 6,89

0,59

1+

11

**INFANO-I 6**

K756-I

5,92 x 3,39 x 2,25

8,92 x 6,89

0,59

1+

11

**DOMETO-I 1-1**

K511-I

4,86 x 4,23 x 2,40

7,85 x 7,23

0,90

3+

10

**DOMETO-I 2-2**

K522-I

6,75 x 5,37 x 2,80

9,75 x 8,87

0,90

3+

16

**DOMETO-I 2-3**

K523-I

7,82 x 5,37 x 2,80

10,82 x 8,87

0,90

3+

16



**DOMETO-I 2-2**  
K522-I



**DOMETO-I 2-3**  
K523-I



**DOMETO-I 1-2**

K512-I

**DOMETO-I 3-1**

K531-I

**DOMETO-I 4-1**

K541-I



<b>DOMETO-I 1-2</b>	K512-I	4,86 x 4,23 x 2,80	7,85 x 7,23	0,90	3+	11
<b>DOMETO-I 3-1</b>	K531-I	7,82 x 5,60 x 2,80	10,82 x 9,10	0,90	3+	18
<b>DOMETO-I 4-1</b>	K541-I	8,45 x 7,55 x 2,80	11,45 x 11,05	0,90	3+	21
<b>DOMO-I 1-2</b>	K612-I	7,14 x 6,65 x 3,73	10,32 x 10,38	2,50	6+	19
<b>DOMO-I 2-1</b>	K621-I	8,02 x 7,56 x 3,73	11,52 x 10,56	2,50	6+	22
<b>DOMO-I 2-4</b>	K624-I	9.20 x 9.13 x 3.73	12.42 x 12.63	2,50	6+	22

**DOMO-I 1-2**

K612-I



**DOMO-I 2-1**

K621-I



**DOMO-I 2-4**

K624-I

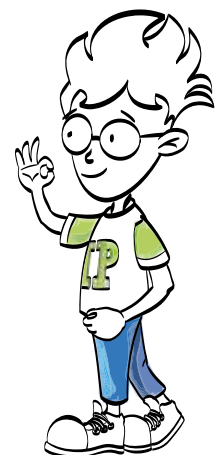



**DOMO-I 4-1**  
K641-I



**DOMO-I 2-2**  
K622-I

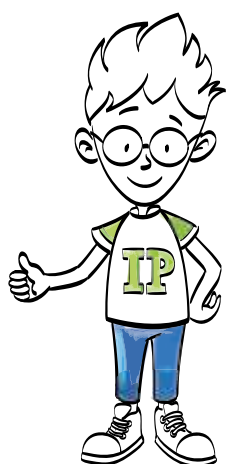

**DOMO-I 4-1**

K641-I

10.55 x 9.73 x 3.73

14.05 x 13.23

2,50

6+

31

**DOMO-I 2-2**

K622-I

8,44 x 8,92 x 3,73

11,44 x 12,42

2,50

6+

20



## Music boards - electronic | Musiktafeln - elektronisch



**SONO 1A**  
FR-IN-01



**SONO 3A**  
FR-IN-02

## Music boards - acoustic | Musiktafeln - akustisch



**AKUSTIKO 1**  
FR-IN-03



**AKUSTIKO 2**  
FR-IN-04



**AKUSTIKO 3**  
FR-IN-05



SONO

0,90 x 0,10 x 1,25

3,90 x 3,10

-

3+

1

AKUSTICO

0,90 x 0,10 x 1,25

3,90 x 3,10

-

3+

1

SENSA

0,90 x 0,10 x 1,25

3,90 x 3,10

-

3+

1

Sensory boards | Sensorische Tafeln



**SENSA 1**  
FR-IN-06

**SENSA 2**  
FR-IN-07

**SENSA 3**  
FR-IN-08

**SENSA 4**  
FR-IN-09

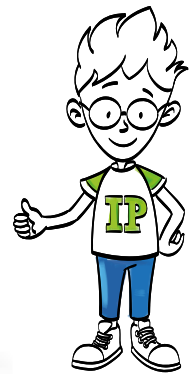

**SENSA 5**  
FR-IN-10

**SENSA 6**  
FR-IN-11

**SENSA 7**  
FR-IN-12





SENSA

0,90 x 0,10 x 1,25

3,90 x 3,10

-

3+

1

EDITO SMALL

0,90 x 0,10 x 1,25

3,90 x 3,10

-

3+

1



**SENSA 8**  
FR-IN-13



**SENSA 9**  
FR-IN-14

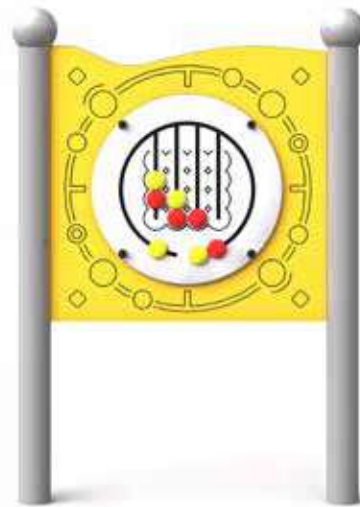

**SENSA 10**  
FR-IN-15



**SENSA 11**  
FR-IN-16



**EDITO 1**  
K811



**EDITO 2**  
K812



**EDITO 3**  
K813



**EDITO 4**  
K814



**EDITO 5**  
IS-TA-101



**EDITO 6**  
IS-TA-102



**EDITO 7**  
IS-TA-103



**EDITO 8**  
IS-TA-104



**EDITO 9**  
IS-TA-105



**EDITO 10**  
IS-TA-106



**EDITO 11**  
IS-TA-107



**EDITO 12**  
IS-TA-108



**EDITO 13**  
IS-TA-109

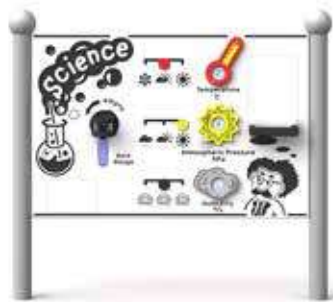

**EDITO 14**  
IS-TA-110



**EDITO 15**  
IS-TA-111



**EDITO 16**  
IS-TA-112



**EDITO SMALL**

0,90 x 0,10 x 1,25

3,90 x 3,10

-

3+

1

**EDITO MIRRORS**

0,78 x 0,10 x 1,50

3,78 x 3,10

-

3+

2

**EDITO BIG**

1,65 x 0,10 x 1,25

4,65 x 3,10

-

3+

2



**EDITO 17**  
IS-TA-201



**EDITO 18**  
IS-TA-202



**EDITO 19**  
IS-TA-203



**EDITO 20**  
IS-TA-204





**EDITO 21**  
IS-TA-205



**EDITO 22**  
IS-TA-206



**EDITO 23**  
IS-TA-207



**EDITO 24**  
IS-TA-208

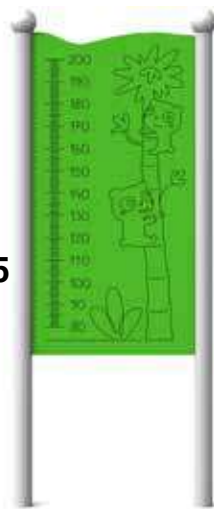

**EDITO 25**  
IS-TA-209



**EDITO 26**  
IS-TA-210



**EDITO 27**  
IS-TA-113



**EDITO 29**  
IS-TA-212



**EDITO HIGH**

0,90 x 0,10 x 2,22

3,90 x 3,10

-

3+

2

**EDITO BIG**

1,65 x 0,10 x 1,25

4,65 x 3,10

-

3+

2

**EDITO SHOPS**

0,90 x 0,10 x 1,25

3,90 x 3,10

-

3+

2

**PARO**

1,65 x 0,10 x 1,25

4,65 x 3,10

-

3+

2



**PARO 1**  
FR-IN-17



**PARO 2**  
FR-IN-18



**PARO 3**  
FR-IN-19



**PARO 4**  
FR-IN-20



**PARO 5**  
FR-IN-21



**PARO 6**  
FR-IN-22



**PARO 7**  
FR-IN-23



**PARO 8**  
FR-IN-24



**PARO 9**  
FR-IN-25



**PARO 10**  
FR-IN-26



**PARO 11**  
FR-IN-27



**PARO 12**  
FR-IN-28



**PARO 13**  
FR-IN-29



**PARO**

1,65 x 0,10 x 1,25

4,65 x 3,10

-

3+

2

**MUTAJ 3**

1,16 x 1,33 x 1,50

4,16 x 4,33

-

3+

3

**MUTAJ 4**

1,54 x 1,54 x 1,50

4,54 x 4,54

-

3+

4



**MUTAJ 3A**  
FR-IN-30



**MUTAJ 3B**  
FR-IN-31



**MUTAJ 4A**  
FR-IN-32



**MUTAJ 4B**  
FR-IN-33





Linarium







**LINARIUM series comprises rope devices for climbing which are intended for playgrounds and sports facilities. All products of this series are not only a guarantee of great fun, but also develop motor coordination and help to initiate physical activity.**

**LINARIUM eine Serie sehr attraktiver Geräte für Spielplätze, Freizeit- und Sportanlagen. Die Produkte dieser Serie garantieren nicht nur viel Spaß, sondern entwickeln auch die Bewegungskoordination und helfen, körperliche Aktivität zu initiieren.**

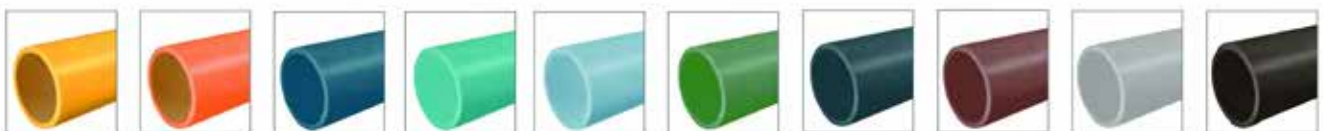
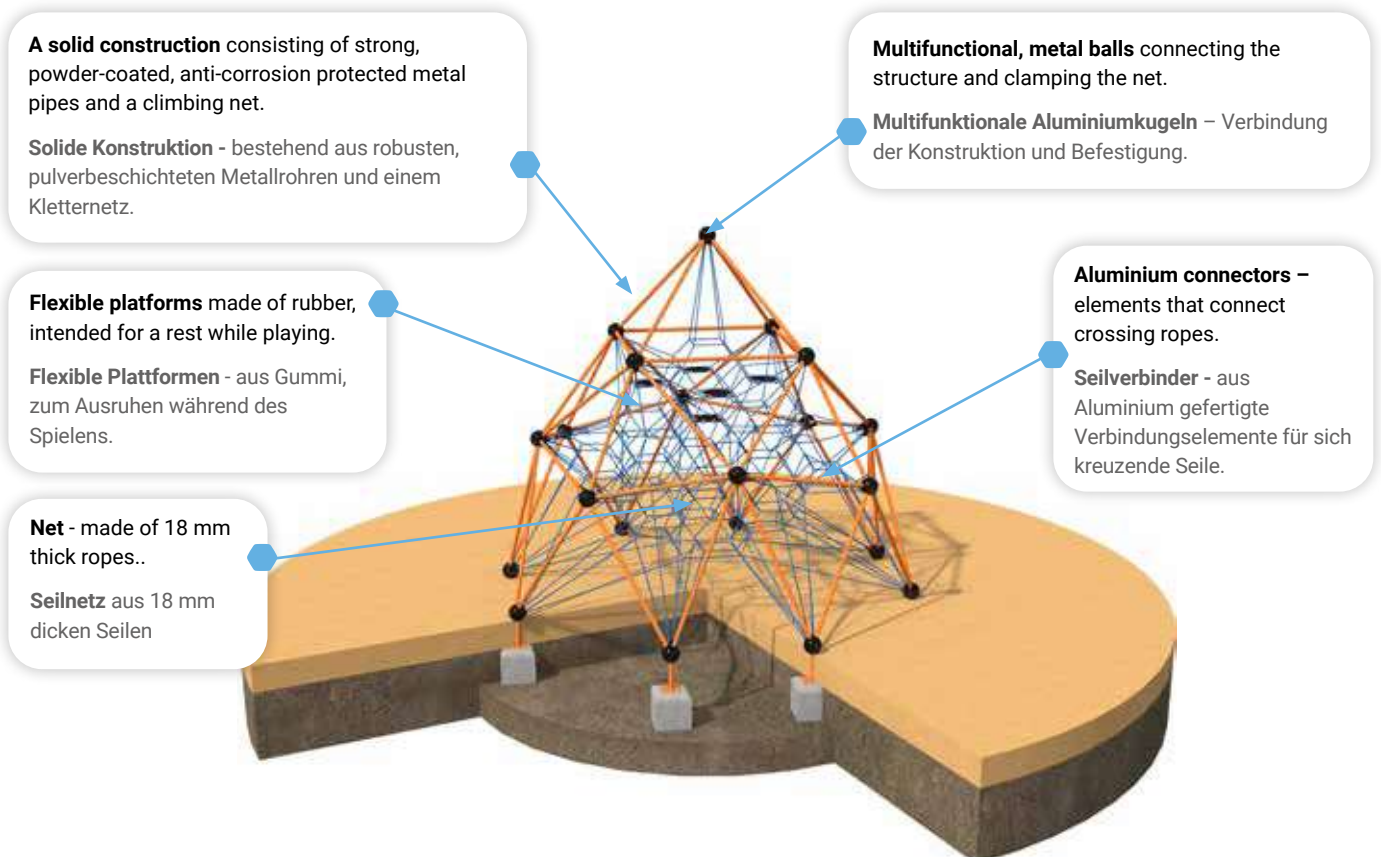

RAL 1003 RAL 2008 RAL 5001 RAL 5018 RAL 5024 RAL 6011 RAL 7026 RAL 8002 RAL 9006 RAL 9005

### Steel construction | Konstruktion aus Stahl



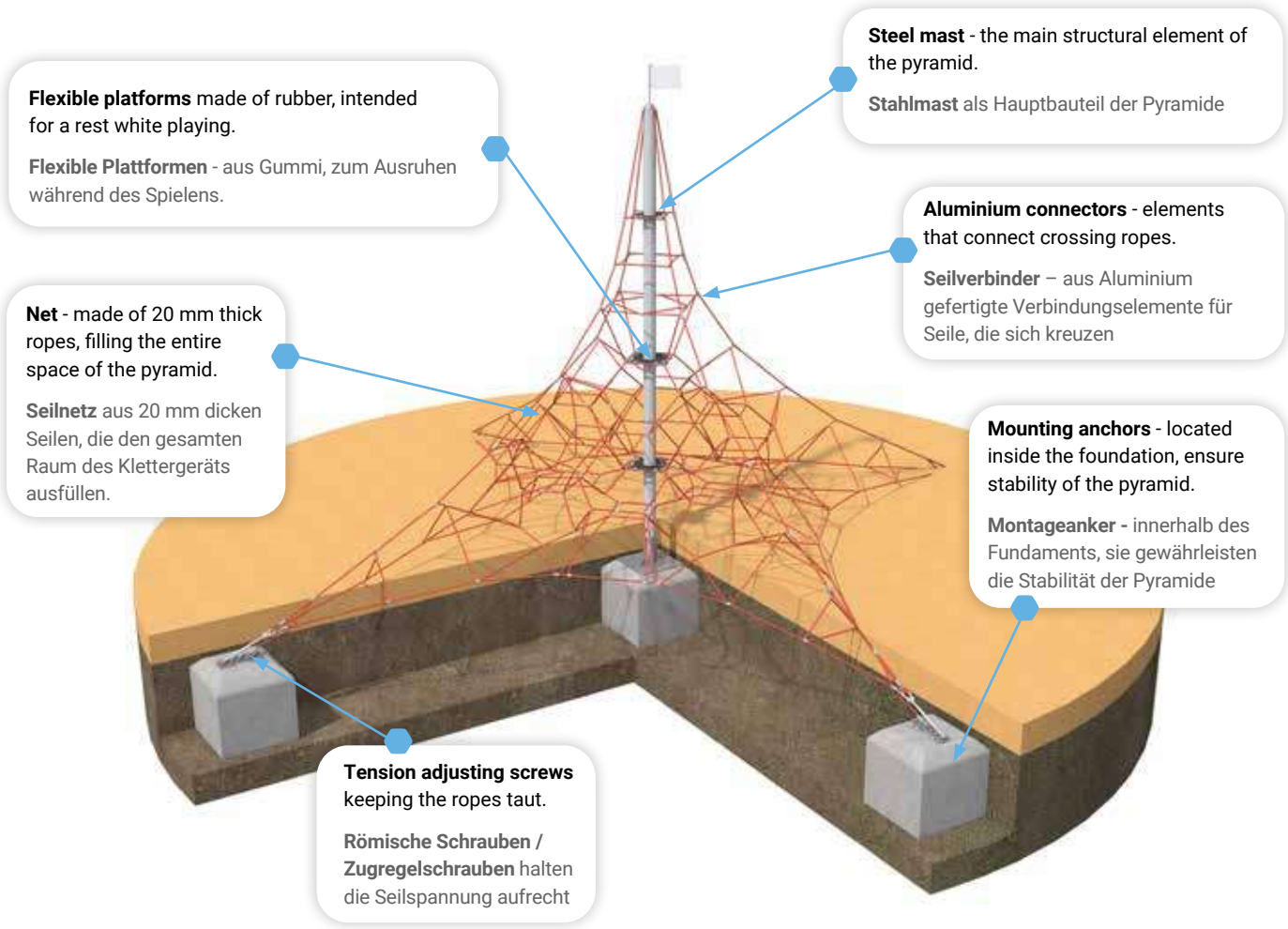

**Flexible platforms** made of rubber, intended for a rest while playing.

**Flexible Plattformen** - aus Gummi, zum Ausruhen während des Spielens.

**Steel mast** - the main structural element of the pyramid.

**Stahlmast** als Hauptbauteil der Pyramide

**Aluminium connectors** - elements that connect crossing ropes.

**Seilverbinder** - aus Aluminium gefertigte Verbindungselemente für Seile, die sich kreuzen

**Net** - made of 20 mm thick ropes, filling the entire space of the pyramid.

**Seilnetz** aus 20 mm dicken Seilen, die den gesamten Raum des Klettergeräts ausfüllen.

**Mounting anchors** - located inside the foundation, ensure stability of the pyramid.

**Montageanker** - innerhalb des Fundaments, sie gewährleisten die Stabilität der Pyramide

**Tension adjusting screws** keeping the ropes taut.

**Römische Schrauben / Zugregelschrauben** halten die Seilspannung aufrecht



Black Schwarz



Brown Braun



Red Rot



Blue Blau



Green Grün



Gray Grau

**Strong 20 mm thick rope | Starkes 20 mm breites Seil**

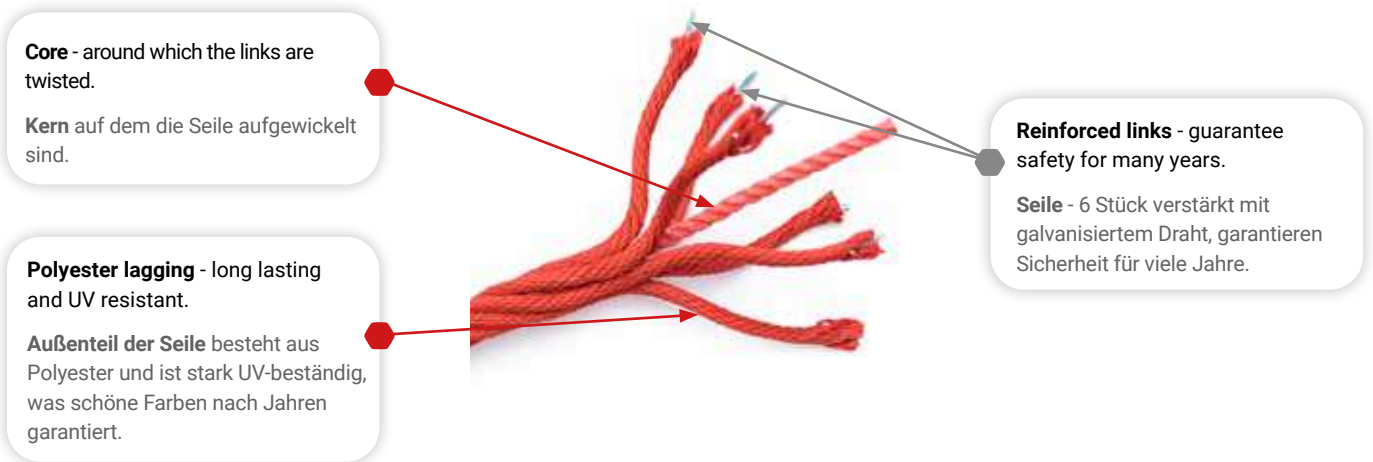

**Core** - around which the links are twisted.

**Kern** auf dem die Seile aufgewickelt sind.

**Reinforced links** - guarantee safety for many years.

**Seile** - 6 Stück verstärkt mit galvanisiertem Draht, garantieren Sicherheit für viele Jahre.

**Polyester lagging** - long lasting and UV resistant.

**Außenteil der Seile** besteht aus Polyester und ist stark UV-beständig, was schöne Farben nach Jahren garantiert.

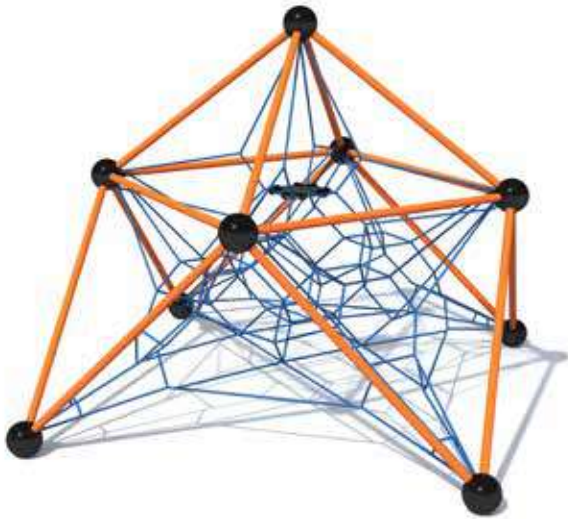

**PINTO 30**  
CR-LI-P30

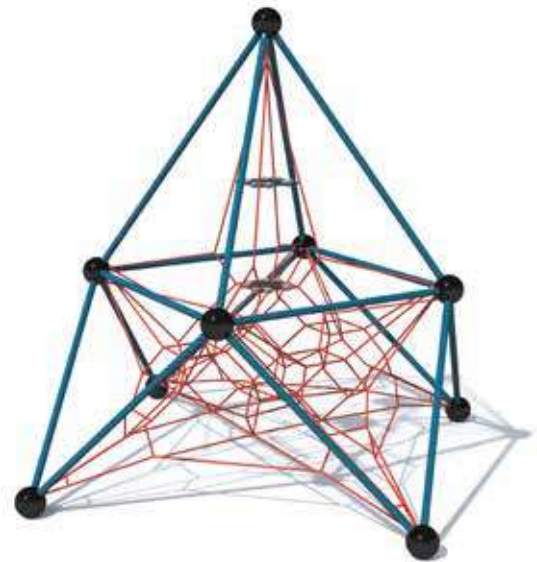

**PINTO 40**  
CR-LI-P40

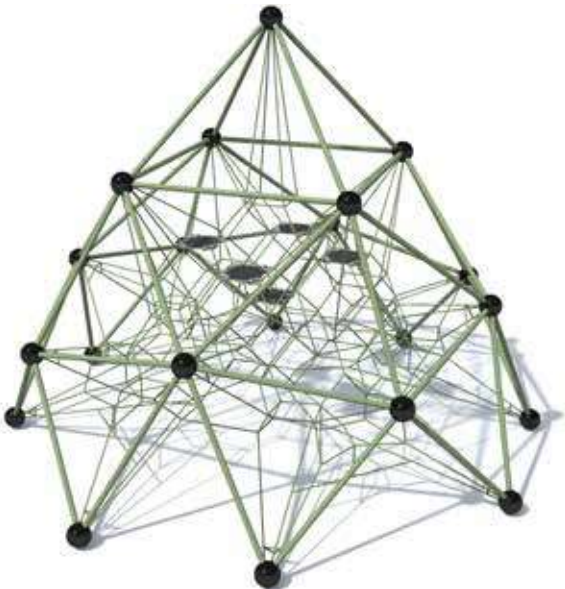

**PINTO 50**  
CR-LI-P50

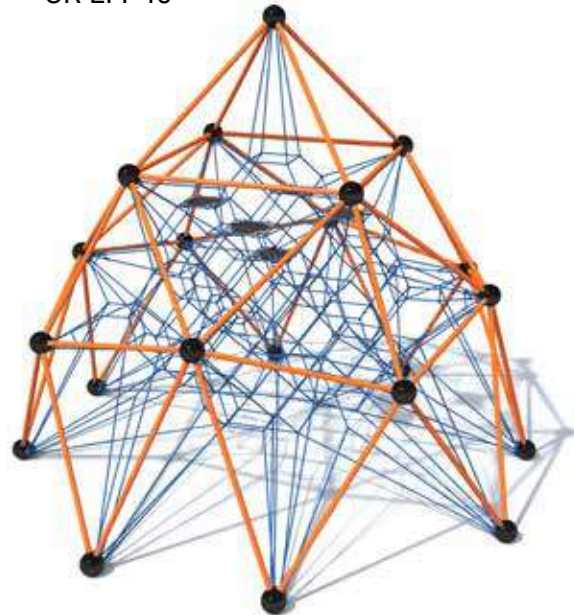

**PINTO 55**  
CR-LI-P55



<b>PINTO 30</b>	CR-LI-P30	3,40 x 3,40 x 3,00	6,83 x 6,83	1,82	3+	22
<b>PINTO 40</b>	CR-LI-P40	3,85 x 3,85 x 4,00	7,25 x 7,25	1,82	3+	22
<b>PINTO 50</b>	CR-LI-P50	5,90 x 5,90 x 5,00	9,15 x 9,15	2,04	3+	42
<b>PINTO 55</b>	CR-LI-P55	5,90 x 5,90 x 5,50	9,75 x 9,75	2,61	3+	43
<b>DIAMANTO 35</b>	CR-LI-D35	4,70 x 4,70 x 3,50	8,30 x 8,30	1,92	3+	49
<b>DIAMANTO 45</b>	CR-LI-D45	4,70 x 4,70 x 4,50	8,15 x 8,15	1,82	3+	54
<b>DIAMANTO 55</b>	CR-LI-D55	4,70 x 4,70 x 5,50	8,15 x 8,15	1,82	3+	56

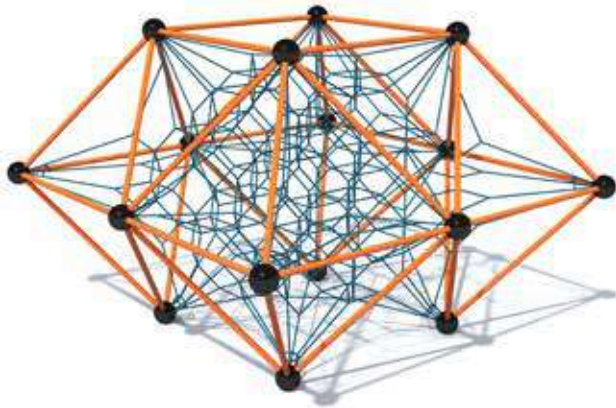

**DIAMANTO 35**  
CR-LI-D35

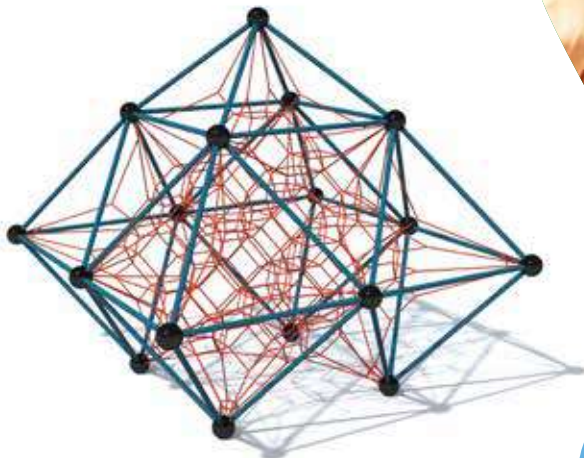

**DIAMANTO 45**  
CR-LI-D45

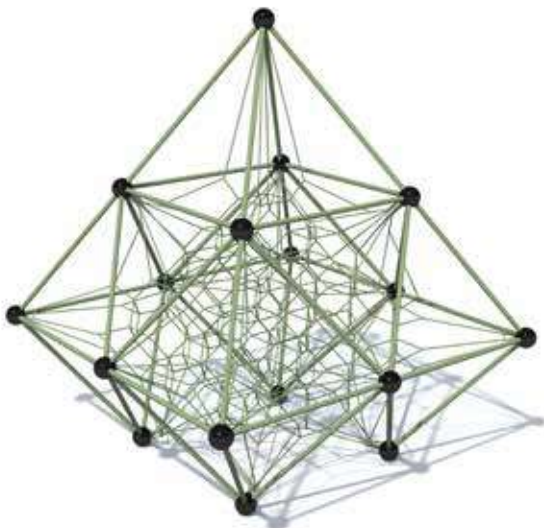

**DIAMANTO 55**  
CR-LI-D55

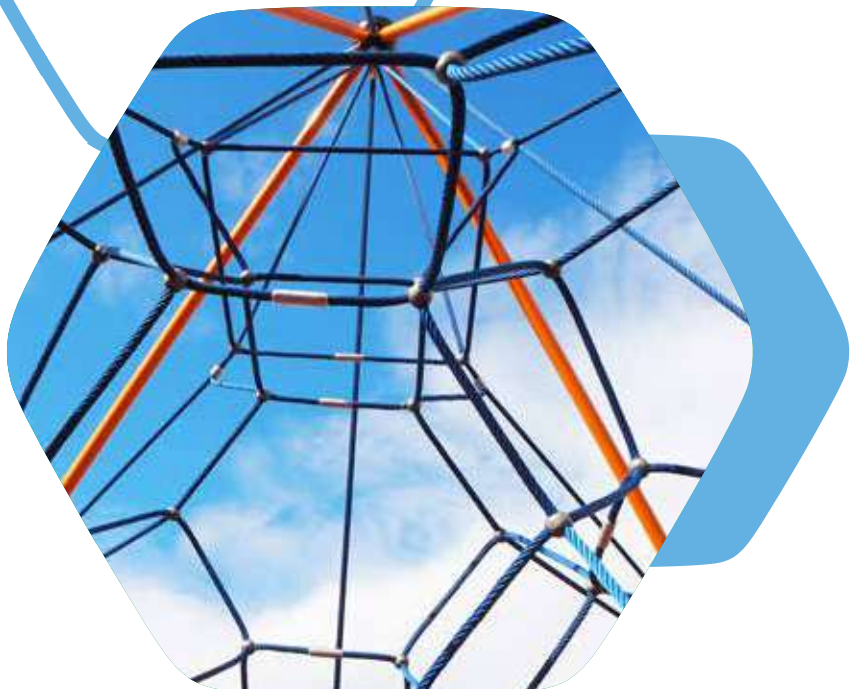

## PIRAMIDO T35



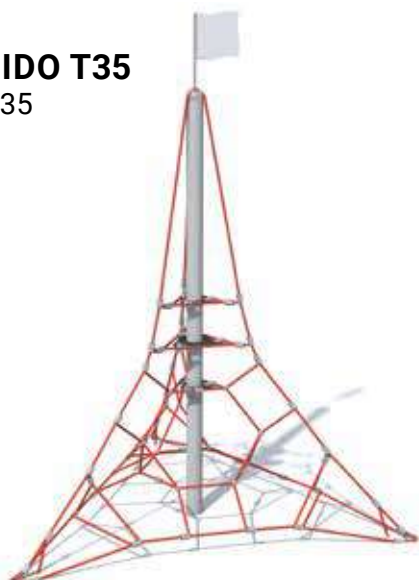



CR-LI-PT35

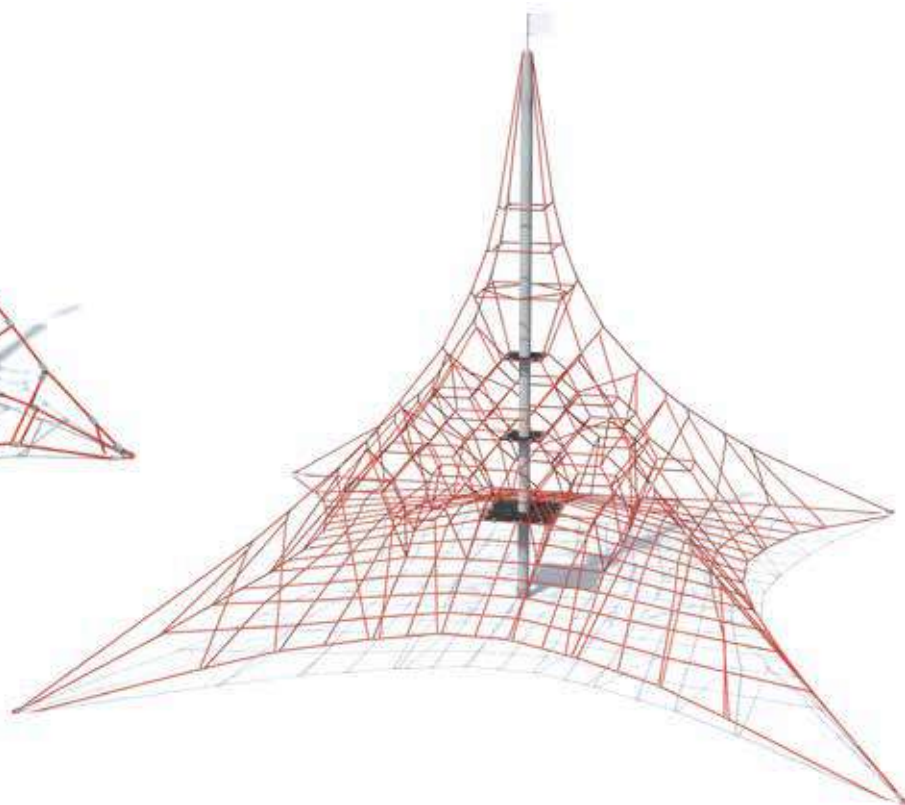

## PIRAMIDO Q85

CR-LI-PQ85



							
<b>PIRAMIDO T 35</b>	CR-LI-PT35	2,65 x 2,30 x 3,50	5,65 x 5,30	0,30	3+	13	
<b>PIRAMIDO Q 35</b>	CR-LI-PQ35	2,80 x 2,80 x 3,50	5,80 x 5,80	0,29	3+	12	
<b>PIRAMIDO Q 40</b>	CR-LI-PQ40	5,75 x 5,75 x 4,00	8,75 x 8,75	0,69	3+	28	
<b>PIRAMIDO Q 45</b>	CR-LI-PQ45	5,75 x 5,75 x 4,50	8,75 x 8,75	0,69	3+	29	
<b>PIRAMIDO Q 55</b>	CR-LI-PQ55	6,95 x 6,95 x 5,50	9,95 x 9,95	0,61	3+	42	
<b>PIRAMIDO Q 65</b>	CR-LI-PQ65	7,70 x 7,70 x 6,50	10,70 x 10,70	1,09	3+	48	
<b>PIRAMIDO Q 75</b>	CR-LI-PQ75	10,75 x 10,75 x 7,50	13,75 x 13,75	1,22	3+	140	
<b>PIRAMIDO Q 85</b>	CR-LI-PQ85	10,75 x 10,75 x 8,50	13,75 x 13,75	1,22	3+	140	
<b>PIRAMIDO P 50</b>	CR-LI-PP50	6,90 x 6,55 x 5,00	9,90 x 9,55	1,20	3+	13	
<b>PIRAMIDO P 65</b>	CR-LI-PP65	11,00 x 10,50 x 6,50	14,00 x 13,50	0,48	3+	22	
<b>PIRAMIDO S 55</b>	CR-LI-PS55	7,80 x 6,75 x 5,50	10,80 x 9,75	0,75	3+	40	
<b>PIRAMIDO S 65</b>	CR-LI-PS65	11,80 x 10,20 x 6,50	14,80 x 13,20	0,49	3+	46	
<b>PIRAMIDO S 85</b>	CR-LI-PS85	11,80 x 10,20 x 8,50	14,80 x 13,20	0,49	3+	52	

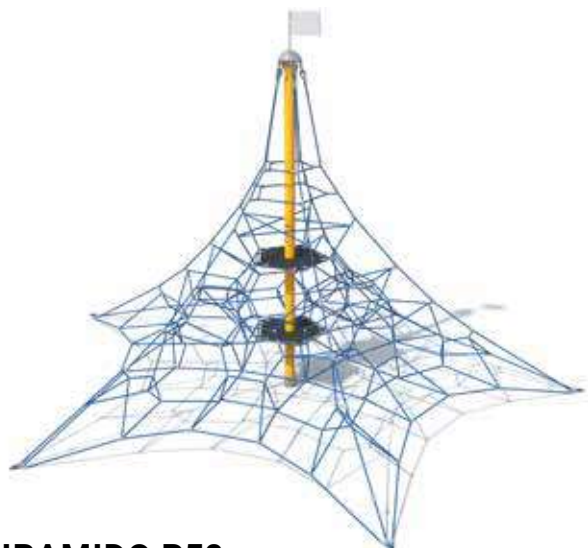

**PIRAMIDO P50**  
CR-LI-PP50

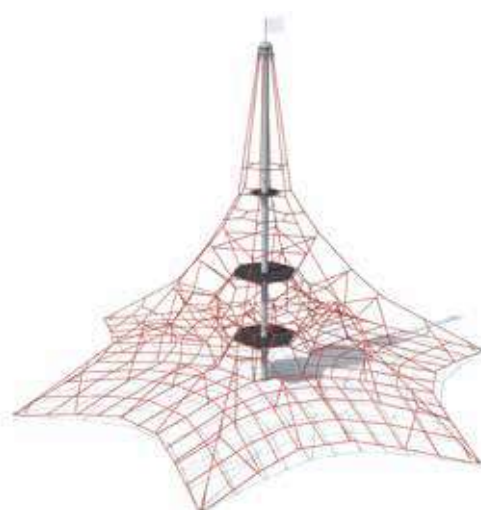

**PIRAMIDO S85**  
CR-LI-PS85



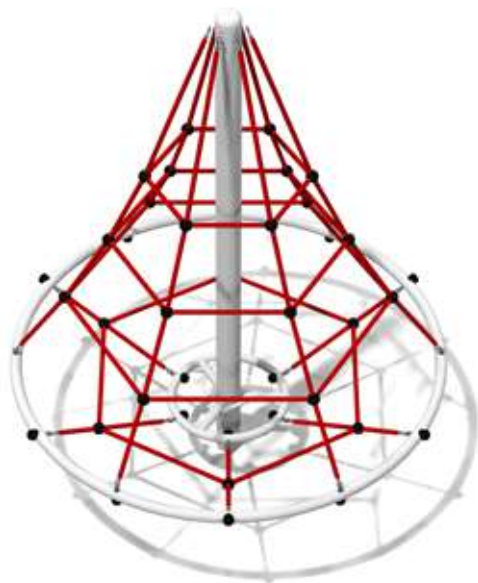

**MT. ASTER**  
GM0701-T



**MT. MNICH**  
W101

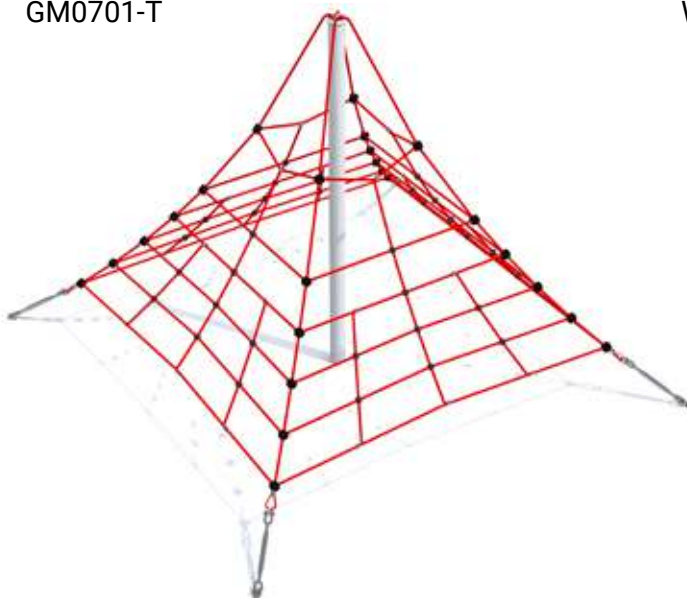

**MT. GERLACH**  
W102

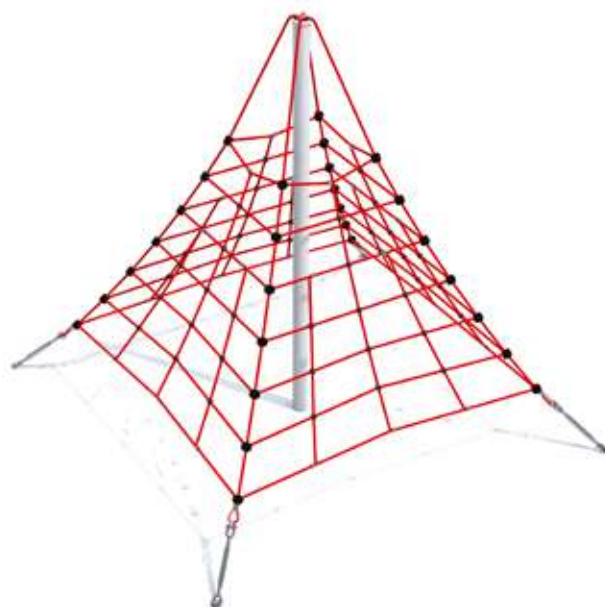

**MT. ROSA**  
W103



Model	Code	Dimensions (L x W x H)	Footprint (L x W)	Height	Age Group	Climbing Points
<b>MT. ASTER</b>	GM0701-T	1,58 x 1,58 x 2,00	4,58 x 4,58	1,33	3+	4
<b>MT. MNICH</b>	W101	2,60 x 2,60 x 2,00	4,80 x 4,80	1,50	3+	4
<b>MT. GERLACH</b>	W102	3,60 x 3,60 x 2,70	5,60 x 5,60	1,90	3+	8
<b>MT. ROSA</b>	W103	3,10 x 3,10 x 3,00	5,30 x 5,30	2,10	3+	12
<b>MT. ELBRUS</b>	W104	3,60 x 3,60 x 3,50	5,80 x 5,80	2,55	3+	16
<b>MT. RYSY</b>	W105	8,00 x 4,00 x 3,00	11,00 x 7,00	3,00	3+	10

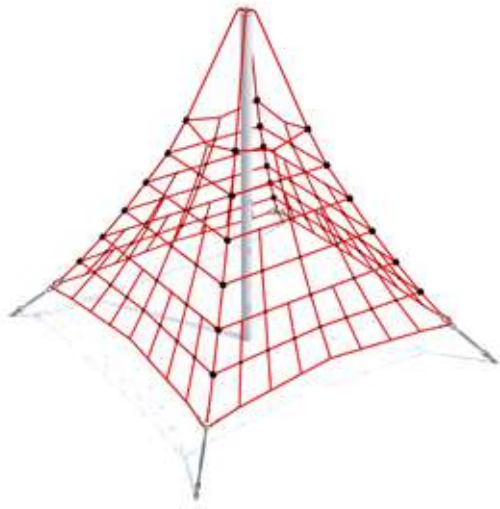

**MT. ELBRUS**  
W104

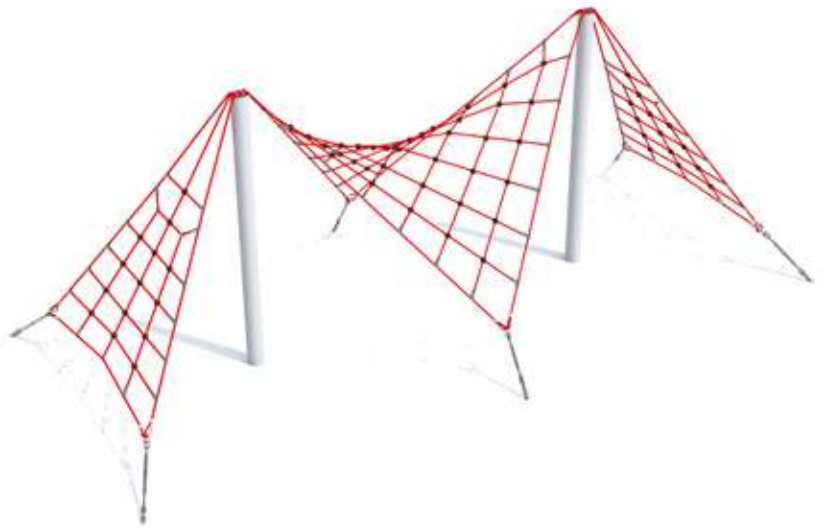

**MT. RYSY**  
W105



**TRANSPORTO**



POLICE



# TRANSPORTO Series

Vehicles are very popular toys found on playgrounds all around the world. Every child can take on the role of a driver, captain, pilot, or astronaut. The TRANSPORTO series stimulates imagination and offers many opportunities for play..

# Serie TRANSPORTO

Fahrzeuge sind sehr beliebte Spielzeuge, die auf Spielplätzen auf der ganzen Welt zu finden sind. Jedes Kind kann in die Rolle eines Fahrers, Kapitäns, Piloten oder Astronauten schlüpfen. Die TRANSPORTO-Serie regt die Fantasie an und bietet zahlreiche Spielmöglichkeiten.

HDPE and HPL panels give the toy its shape and character.

HDPE- und HPL-Platten verleihen dem Spielgerät Form und Charakter.

The powder-coated steel structure ensures safety during play.

Die Konstruktion aus Edelstahl oder pulverbeschichtetem Stahl sorgt für Sicherheit beim Spielen.

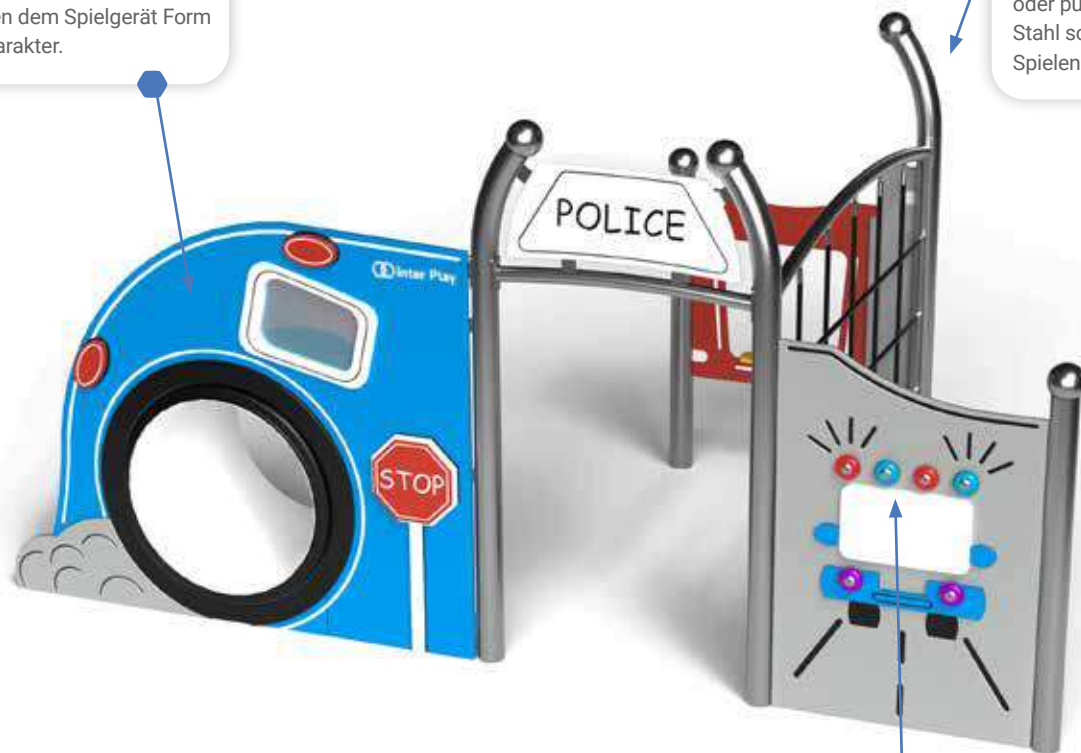

Interactive elements enhance the fun.

Interaktive Elemente erhöhen den Spielspaß und die Attraktivität des Spielgeräts.



**FARM  
BAUERNHOF**  
01-TR-701



**HARBOUR  
HAFEN**  
01-TR-702



**POLICE STATION  
POLIZEIATION**  
01-TR-703



<b>FARM, BAUERNHOF</b>	01-TR-701	3,27 x 1,73 x 1,58	6,26 x 4,72	1,28	1+	10
<b>HARBOUR, HAFEN</b>	01-TR-702	3,68 x 1,73 x 1,58	6,65 x 4,71	1,28	1+	10
<b>POLICE STATION, POLIZEIATION</b>	01-TR-703	3,17 x 1,73 x 1,58	6,16 x 4,71	1,28	1+	10

monto





## Embankment slides and tunnels | Hangrutschen und Kriechtunnel

Option I - straight entrance tunnel (Kanalo).  
Option II - sloped entrance tunnel (Tunelo).

Variante I - Eingang senkrecht geschnitten (Kanalo).  
Variante II - Eingang schräg geschnitten (Tunelo)

Stainless steel.  
Edelstahl.

Option I - narrow slide (Gliti).  
Option II - wide slide (Eliri).

Variante I - schmale Rutsche (Gliti).  
Variante II - breite Rutsche (Eliri).

Different lengths of tunnels.

Mehrere Tunnellängen.

Different lengths of slides.

Mehrere Rutschenlängen.



## Rail slides. | Doppelrutschstange.

Foundations.  
Fundamente.

Any number of handrails available.

Beliebige Anzahl der Handläufen

Different lengths of slides.

Mehrere Rutschenlängen.

Stainless steel.  
Edelstahl.

Multiple colors

Mehrere Farben

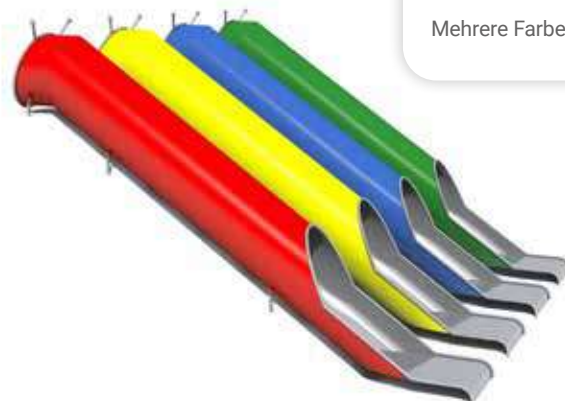

The starting platform eliminates dirt on the slide.  
Additionally, it protects the surface from wear.

Die Startplattform entfernt Schmutz von der Rutsche.  
Zudem schützt sie den Untergrund vor Abnutzung.



**GLITI****ELIRI****RELO****GLITI-S****TUBO****GLITI INCLUSIVE****GLITI RACE****GLITI / ELIRI / RELO / GLITI RACE / TUBO / GLITI INCLUSIVE - parameters**

PRODUCT PRODUKT	CODE	L1 - EMBANKMENT HEIGHT L1 - BÖSCHUNG- HÖHE	L2 - EMBANKMENT LENGTH L2 - BÖSCHUNG- LÄNGE	A - SAFETY ZONE A - SICHERHEITS- ZONE
GLITI H825 ELIRI H825 RELO H825 GLITI H825 RACE	LL-MO-001 LL-MO-021 LL-MO-101 01-MO-371	600-825	1475	1500
GLITI H1000 ELIRI H1000 RELO H1000 GLITI H1000 RACE	LL-MO-007 LL-MO-027 LL-MO-107 01-MO-372	775-1000	1788	1500
GLITI H1350 ELIRI H1350 RELO H1350 GLITI H1350 RACE TUBO H1350	LL-MO-002 LL-MO-022 LL-MO-102 01-MO-373 IS-MO-505	950-1350	2414	2000
GLITI H1700 ELIRI H1700 RELO H1700 GLITI H1700 RACE TUBO H1700 GLITI H1700 INCLUSIVE	LL-MO-003 LL-MO-023 LL-MO-103 01-MO-374 IS-MO-501 01-MO-361	1300-1700	3040	2000

PRODUCT PRODUKT	CODE	L1 - EMBANKMENT HEIGHT L1 - BÖSCHUNGS- HÖHE	L2 - EMBANKMENT LENGTH L2 - BÖSCHUNGS- LÄNGE	A - SAFETY ZONE A - SICHERHEITS- ZONE
GLITI H2050 ELIRI H2050 RELO H2050 GLITI H2050 RACE TUBO H2050 GLITI H2050 INCLUSIVE	LL-MO-004 LL-MO-024 LL-MO-104 01-MO-375 IS-MO-502 01-MO-362	1650-2050	3666	2000
GLITI H2400 ELIRI H2400 RELO H2400 GLITI H2400 RACE TUBO H2400 GLITI H2400 INCLUSIVE	LL-MO-008 LL-MO-028 LL-MO-108 01-MO-376 IS-MO-506 01-MO-363"	2000-2400	4292	2000
GLITI H2750 ELIRI H2750 RELO H2750 GLITI H2750 RACE TUBO H2750 GLITI H2750 INCLUSIVE	LL-MO-005 LL-MO-025 LL-MO-105 01-MO-377 IS-MO-503 01-MO-364	2350-2750	4918	2000
GLITI H3100 ELIRI H3100 RELO H3100 GLITI H3100 RACE TUBO H3100 GLITI H3100 INCLUSIVE	LL-MO-006 LL-MO-026 LL-MO-106 01-MO-378 IS-MO-504 01-MO-365	2700-3100	5544	2000
GLITI-S H3600	IS-MO-401	3100-3500	6259	2000
GLITI-S H4100	IS-MO-402	3600-4000	7153	2000
GLITI-S H4600	IS-MO-403	4100-4500	8047	2000
GLITI-S H5100	IS-MO-404	4600-5000	8941	2000

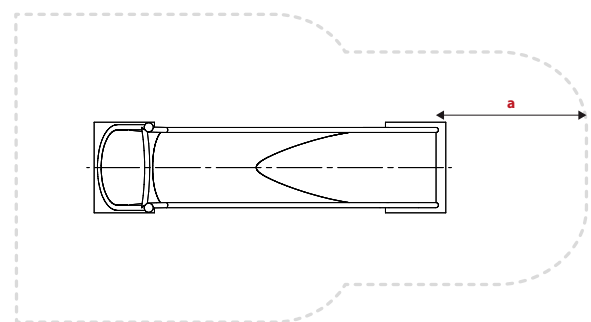
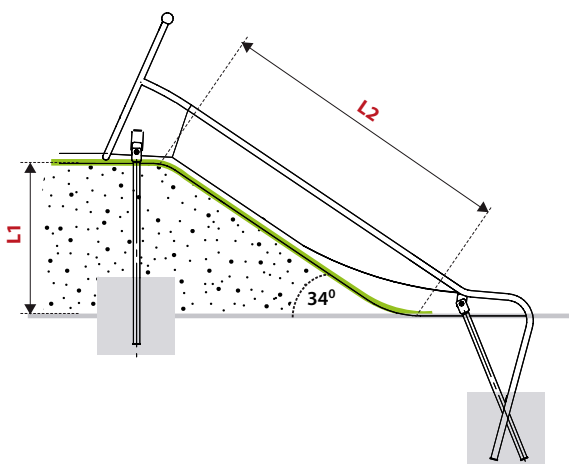

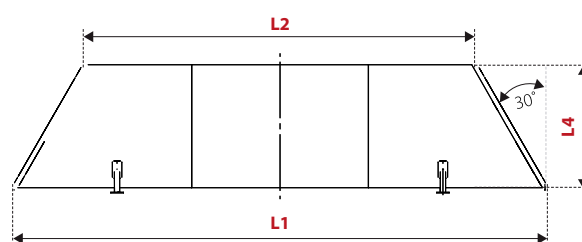
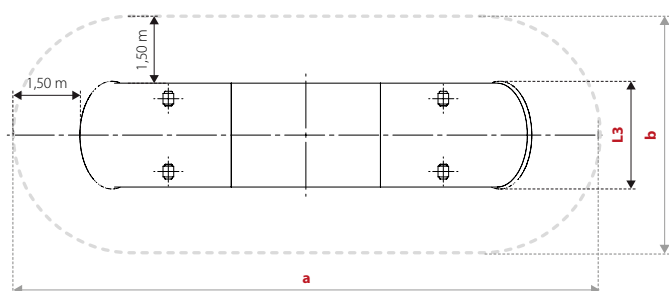

## TUNELO

PRODUCT PRODUKT	CODE CODE	L1	L2	L3	L4	AxB
TUNELO 200	LL-MO-202	2,90 m	2,00 m	0,85 m	0,78 m	5,90 x 3,85 m
TUNELO 250	LL-MO-204	3,40 m	2,50 m	0,85 m	0,78 m	6,40 x 3,85 m
TUNELO 300	LL-MO-206	3,90 m	3,00 m	0,85 m	0,78 m	6,90 x 3,85 m
TUNELO 350	LL-MO-208	4,40 m	3,50 m	0,85 m	0,78 m	7,40 x 3,85 m
TUNELO 400	LL-MO-210	4,90 m	4,00 m	0,85 m	0,78 m	7,90 x 3,85 m
TUNELO 450	LL-MO-212	5,40 m	4,50 m	0,85 m	0,78 m	8,40 x 3,85 m
TUNELO 500	LL-MO-214	5,90 m	5,00 m	0,85 m	0,78 m	8,90 x 3,85 m

**L1** - total length | Gesamtlänge

**L2** - total length | Gesamtlänge

**L3** - total width | Gesamtbreite

**L4** - inner diameter | Innendurchmesser







**A, B** - safety zone | Sicherheitszone



**FRABINA 1200**  
IS-MO-601

**FRABINA 1600**  
IS-MO-602

**FRABINA 2000**  
IS-MO-603

						
<b>FRABINA H 1,2 M</b>	IS-MO-601	3,37 x 0,59 x 1,95 m	6,87 x 3,57 m	1,20 m	3+	1
<b>FRABINA H 1,6 M</b>	IS-MO-602	4,04 x 0,59 x 2,35 m	7,54 x 3,57 m	1,60 m	3+	1
<b>FRABINA H 2,0 M</b>	IS-MO-603	4,79 x 0,59 x 2,75 m	8,29 x 3,57 m	200 m	3+	1

# ROTO





**Roto series has a fun design, eye-catching colors and high quality, durable construction.**

**Die ROTO-Serie hat ein lustiges Design, Drehelemente, auffällige Farben und eine hochwertige, langlebige Konstruktion.**

Galvanized and powder painted steel resistant against rust.

Verzinkter, pulverbeschichteter Stahl.

Polypropylene ropes reinforced with steel cores.

Robuste Polypropylen-Seile.

The walls are made of HDPE boards are resistant to intensive use and are easy to clean. Vivid colors emphasize the aesthetic value of the playground.

Die Anlagewände aus HDPE-Platten für eine intensive Nutzung geeignet; garantieren leichte Reinigung. Lebendigen Farben unterstreichen den ästhetischen Wert des Spielplatzes.

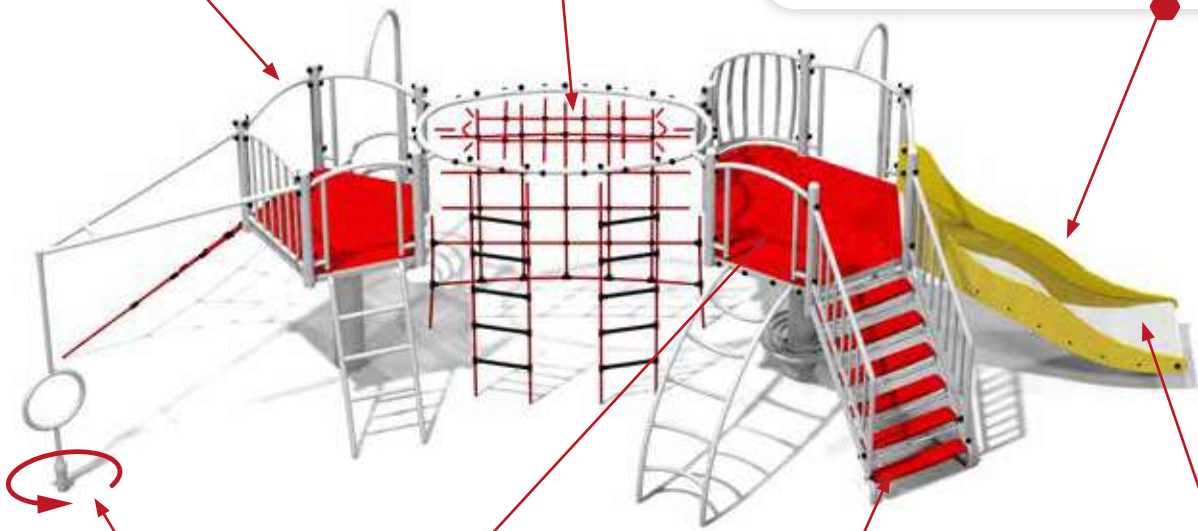

Rotating elements provide great fun.

Rotierende Elemente sorgen für großen Spaß.

Floor and climbing walls made of PE panels with a non-slip structure ensure safety and limit the possibility of uncontrolled slipping.

Boden und Kletterwände aus PE-Kunststoffplatten mit einer rutschfesten Struktur, begrenzen die Möglichkeit des unkontrollierten Rutschens während des Spiels.

Wavy slide provides more fun while playing.

Wellenförmige Rutsche gewährleistet mehr Spaß beim Spielen.

System that slows down swing's arms fall.

Slow System für sanftes Fallen der Schaukelarmen.

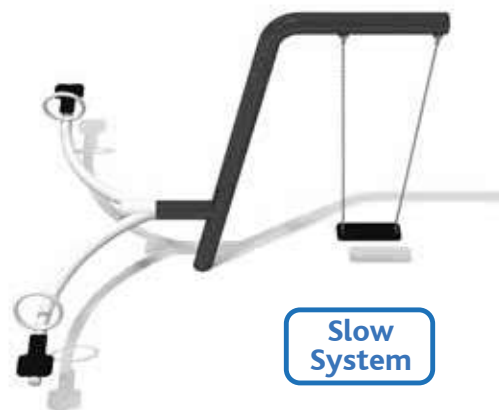

Rotative equipment | Rotierende Spielgeräte

Roundabouts | Klassische Karussells

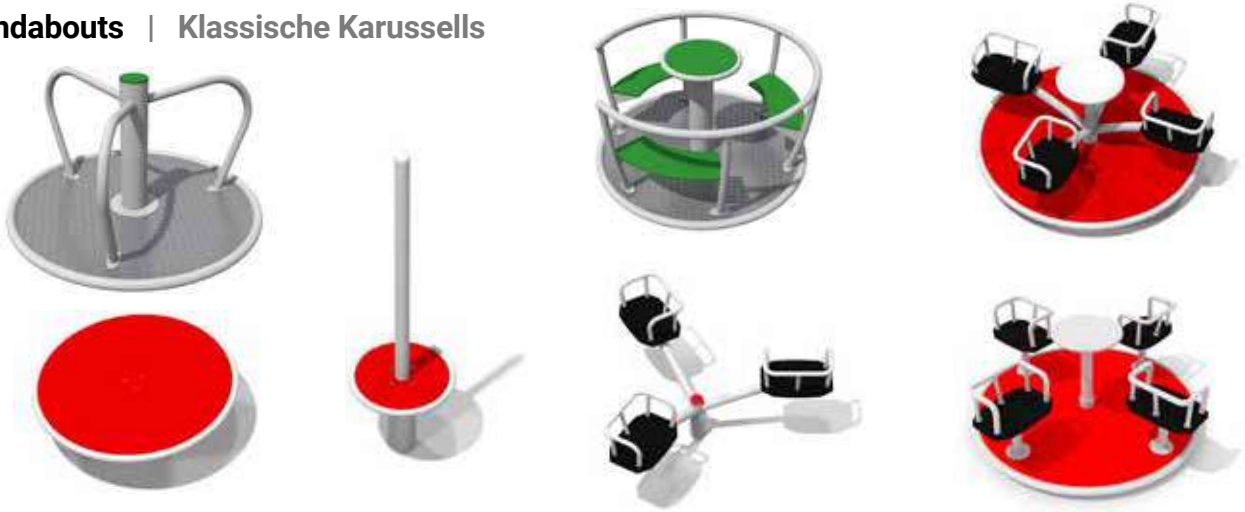

Hanging roundabouts | Rundläufe



Rotative net structures | Rotierende Klettergerüste

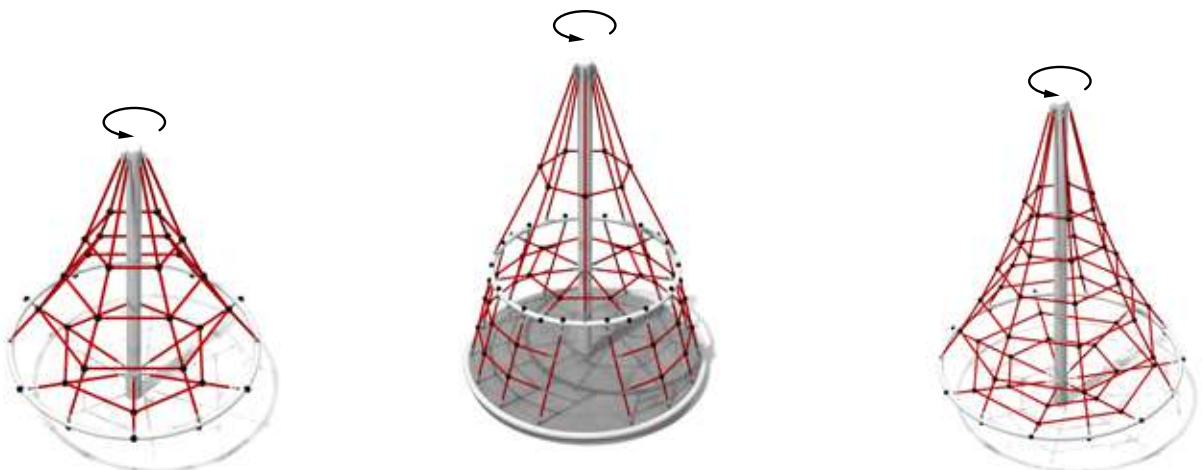



**INDUS**  
GM424501



**ANDROMEDA**  
GM425601





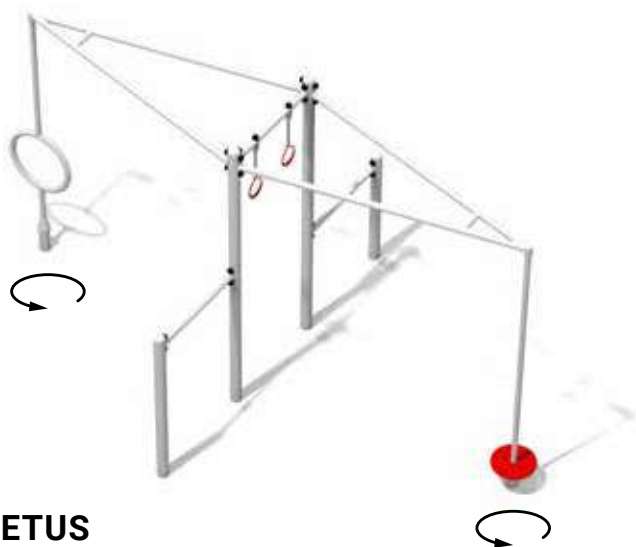

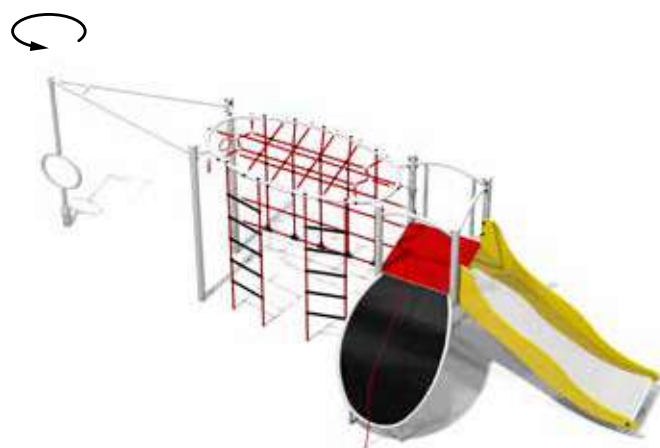

**ORION**  
GM41501



**CETUS**  
GM3400



**GEMINI**  
GM1002

								
<b>INDUS</b>	GM424501			7,67 x 4,47 x 2,35	11,05 x 7,59	1,98	6+	16
<b>ANDROMEDA</b>	GM425601			8,05 x 3,61 x 2,43	11,55 x 6,60	1,98	3+	20
<b>CETUS</b>	GM3400			4,06 x 2,45 x 2,16	7,30 x 5,45	1,65	3+	5
<b>GEMINI</b>	GM41002			6,88 x 2,33 x 2,16	10,36 x 5,40	1,95	3+	8
<b>ORION</b>	GM41501			3,97 x 2,47 x 2,36	7,47 x 5,39	1,26	3+	4
<b>CASSIOPEIA</b>	GM425607			7,32 x 4,23 x 3,16	10,73 x 7,87	1,98	3+	9
<b>SCORPIUS</b>	GM445556			9,22 x 8,91 x 3,16	12,71 x 11,93	1,98	3+	24



**CASSIOPEIA**  
GM425607



**SCORPIUS**  
GM445556





**ZEPHYR 4**  
GM0714









**MONSOON 4**  
GM0724









**SOLANO 2-1**  
GM-RO-151s



						
<b>ZEPHYR 2</b>	GM0712	3,44 x 0,14 x 2,50	8,00 x 8,00	1,50	6+	2
<b>ZEPHYR 3</b>	GM0713	3,01 x 2,61 x 2,50	8,00 x 8,00	1,50	6+	3
<b>ZEPHYR 4</b>	GM0714	3,44 x 3,44 x 2,50	8,00 x 8,00	1,50	6+	4
<b>MONSOON 2</b>	GM0722	3,44 x 0,14 x 2,50	9,47 x 9,47	1,50	6+	2
<b>MONSOON 3</b>	GM0723	3,01 x 2,61 x 2,50	9,47 x 9,47	1,50	6+	3
<b>MONSOON 4</b>	GM0724	3,44 x 3,44 x 2,50	9,47 x 9,47	1,50	6+	4



						
<b>SOLANO 2-1</b>	GM-RO-151s	3,34 x 0,14 x 2,31	8,40 x 8,40	1,50	6+	2
<b>SOLANO 2-2</b>	GM-RO-151b	3,34 x 0,14 x 2,31	8,40 x 8,40	1,50	6+	2
<b>SOLANO 2-3</b>	GM-RO-151sb	3,34 x 0,14 x 2,31	8,40 x 8,40	1,50	6+	2
<b>SOLANO 3-1</b>	GM-RO-152s	2,92 x 2,54 x 2,31	8,40 x 8,40	1,50	6+	3
<b>SOLANO 3-2</b>	GM-RO-152b	2,92 x 2,54 x 2,31	8,40 x 8,40	1,50	6+	3
<b>SOLANO 3-3</b>	GM-RO-152ssb	2,92 x 2,54 x 2,31	8,40 x 8,40	1,50	6+	3
<b>SOLANO 3-4</b>	GM-RO-152sbb	2,92 x 2,54 x 2,31	8,40 x 8,40	1,50	6+	3

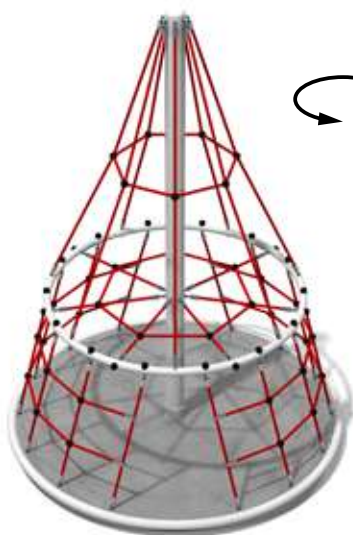

**MT. EVEREST**  
GM0710

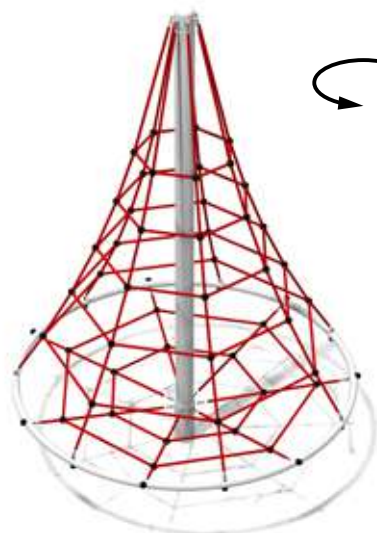

**MT. BLANC**  
GM0704

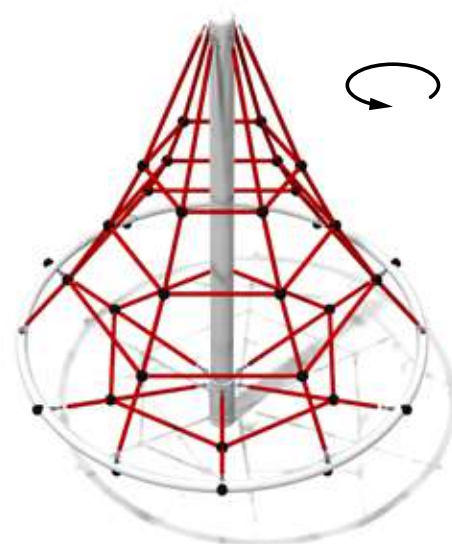

**MT. KASPROWY**  
GM0702

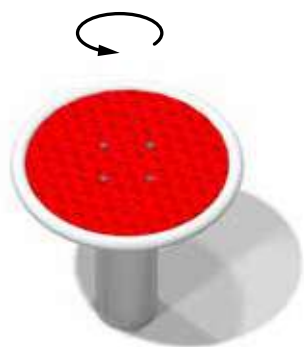





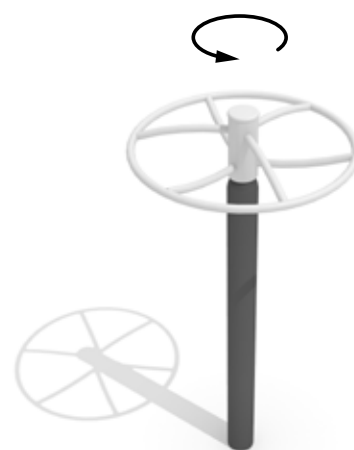

**LOOP**  
GM0410



**PIROUETTE**  
GM0420









**BURAN**  
GM-RO-153

								
<b>MT. EVEREST</b>	GM0710	2,10 x 2,10 x 2,96	6,09 x 6,09	1,98	3+	10		
<b>MT. BLANC</b>	GM0704	2,15 x 2,15 x 3,03	6,15 x 6,15	2,00	3+	8		
<b>MT. KASPROWY</b>	GM0702	1,60 x 1,60 x 2,02	5,60 x 5,60	1,29	3+	6		
<b>LOOP</b>	GM0410	0,30 x 0,30 x 0,29	3,30 x 3,30	1,00	3+	1		
<b>PIROUETTE</b>	GM0420	0,30 x 0,30 x 1,11	3,30 x 3,30	1,00	3+	1		
<b>BURAN</b>	GM-RO-153	0,95 x 0,95 x 2,01	4,95 x 4,95	1,50	6+	3		





						
<b>MISTRAL 3</b>	GM0473P	1,70 x 1,70 x 0,72	5,70 x 5,70	1,00	3+	3
<b>MISTRAL 4</b>	GM0474P	1,70 x 1,70 x 0,72	5,70 x 5,70	1,00	3+	4
<b>BREEZE 3</b>	GK-RO-202	1,58 x 1,58 x 0,73	5,58 x 5,58	1,00	3+	3
<b>BREEZE 4</b>	GK-RO-203	1,58 x 1,58 x 0,73	5,58 x 5,58	1,00	3+	4
<b>TORNADO 130</b>	GM0147-1p-A	1,33 x 1,33 x 0,73	5,33 x 5,33	1,00	3+	4
<b>HURRICANE</b>	GM0324-2P	1,30 x 1,30 x 0,80	5,60 x 5,60	1,00	3+	8
<b>NORTE 130</b>	GK-RO-201-A	1,32 x 1,32 x 0,74	5,32 x 5,32	1,00	3+	6



**MISTRAL 3**  
GM0473P



**MISTRAL 4**  
GM0474P

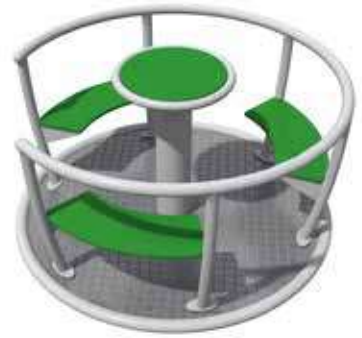

**TORNADO 130**  
GM0147-1p-A



**BREEZE 3**  
GM-RO-202



**BREEZE 4**  
GM-RO-203

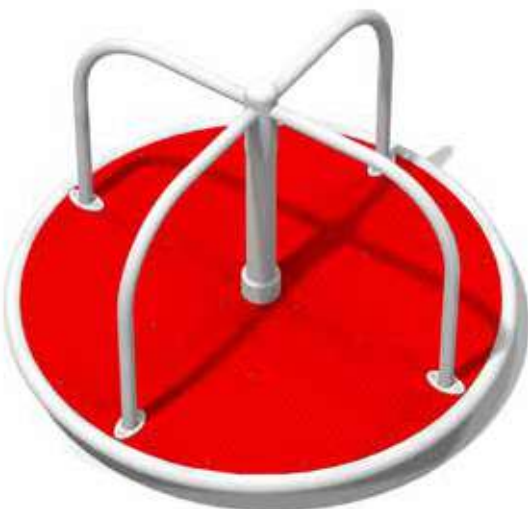

**HURRICANE**  
GM0324-2P

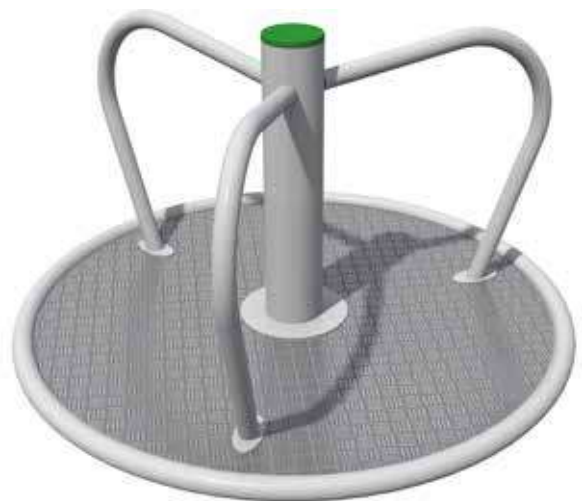

**NORTE 130**  
GK-RO-201-A



**MARIN**  
TO-RO-03



**LESTE**  
TO-RO-02



**PAMPERO**  
TO-RO-01

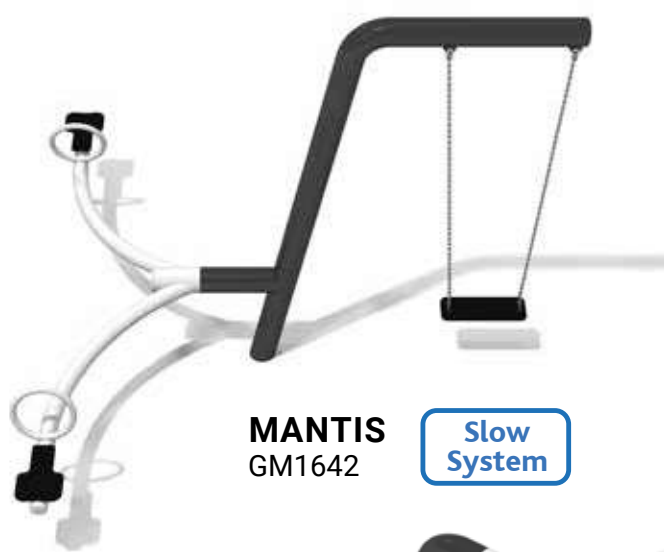

**MANTIS**  
GM1642

Slow  
System





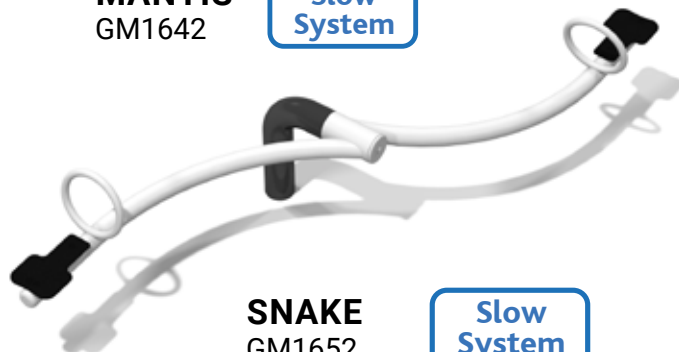



**STARGATE**  
GM1606



**SNAKE**  
GM1652

Slow  
System

						
<b>MARIN</b>	TO-RO-03	0,66 x 0,66 x 1,20	4,66 x 4,66	1,00	3+	1
<b>LESTE</b>	TO-RO-02	1,50 x 1,50 x 0,95	5,50 x 5,50	1,00	3+	6
<b>PAMPERO</b>	TO-RO-01	1,50 x 1,50 x 0,80	5,50 x 5,50	1,00	3+	4
<b>SNAKE</b>	GM1652	3,00 x 1,42 x 1,13	6,00 x 4,42	0,86	3+	2
<b>MANTIS</b>	GM1642	2,80 x 3,00 x 2,29	4,67 x 7,50	1,27	3+	3
<b>STARGATE</b>	GM1606	2,59 x 0,32 x 2,16	1,75 x 7,34	1,20	3+	1





**CRAB**  
GM1654









**OCTOPUS**  
GM1656



**DIGO**  
KS-RO-01



**LOLLIPOP**  
GM7001

								
<b>CRAB</b>	GM1654			3,00 x 2,40 x 1,13	5,40 x 6,00	0,86	3+	4
<b>OCTOPUS</b>	GM1656			5,44 x 4,78 x 1,16	7,78 x 8,44	0,86	3+	6
<b>DIGO</b>	KS-RO-01			1,42 x 0,55 x 0,88	5,20 x 5,20	1,00	3+	1
<b>ASPEN 20M</b>	GM2001-20			23,62 x 4,01 x 3,85	24,0 x 4,45	1,30	6+	1
<b>ASPEN 25M</b>	GM2001-25			28,87 x 4,25 x 4,13	29,0 x 4,45	1,58	6+	1
<b>ASPEN 30M</b>	GM2001-30			34,01 x 4,30 x 4,35	34,5 x 4,45	1,80	6+	1
<b>LOLLIPOP</b>	MA7001			0,6 x 0,05 x 2,18	3,59 x 3,04	-	-	-

**ASPEN**  
GM2001-20



PARK





## Cubic-shaped playgrounds, light in the form. Spielplätze mit einfachem, leichtem Design.

Quick and easy installation.

Einfache und schnelle  
Montage.

The walls are made of HDPE boards, which are resistant to intensive use and are easy to clean. Their vivid colors underline the aesthetic value of the playground.

Die Anlagewände sind aus HDPE-Platten hergestellt, die bei intensiver Nutzung nicht verschleifen und leicht zu reinigen sind. Ihre lebendigen Farben betonen den ästhetischen Wert des Spielplatzes.

Galvanized and powder painted steel resistant to rust.

Verzinkter, pulverbeschichteter  
Stahl.

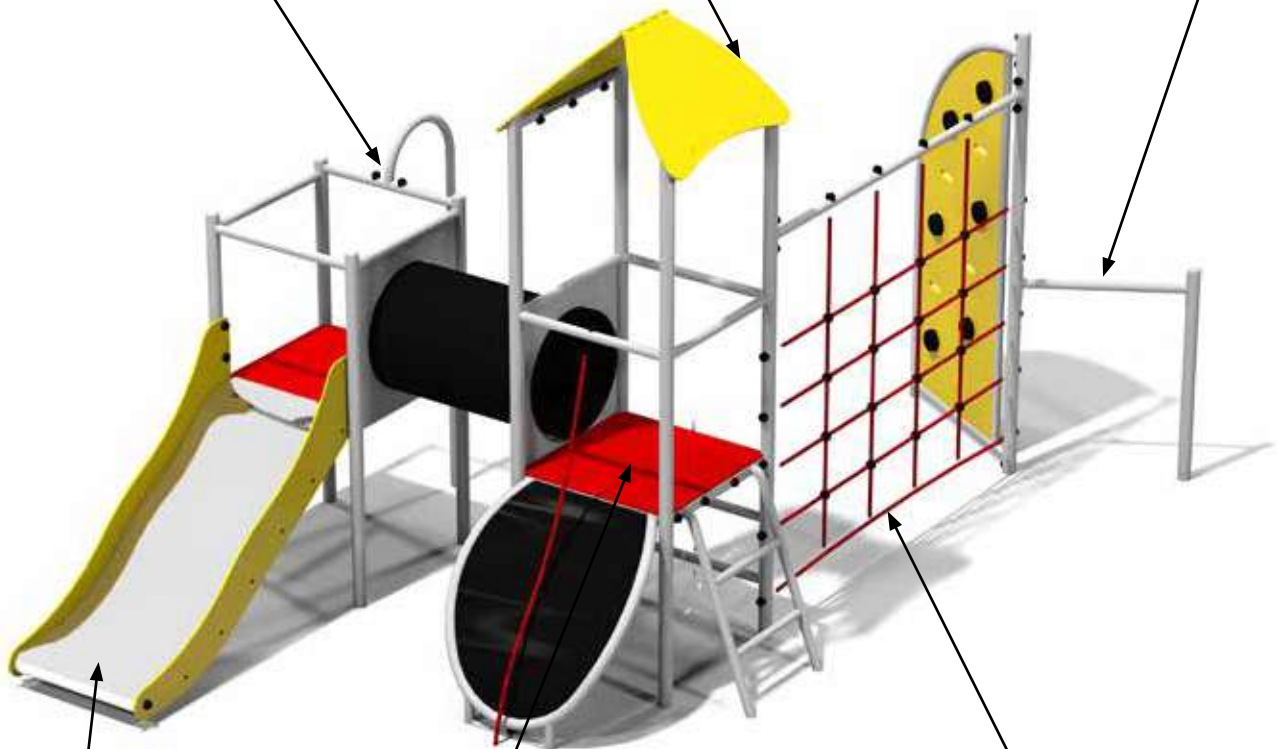

Wave-shaped slide  
guarantees great fun..

Wellenförmige Rutsche  
gewährleistet mehr  
Spaß beim Spielen.

PE panels with a non-slip structure  
ensure safety  
and limit the possibility of uncontrolled slipping  
during play.

PE-Kunststoffplatten mit einer rutschfesten  
Struktur gewährleisten die Sicherheit und  
begrenzen die Möglichkeit des unkontrollierten  
Rutschens während des Spiels.

Durable polypropylene ropes are reinforced  
with a steel cores to ensure safety while  
playing.

Langlebige Polypropylen-Seile, sind mit  
einem Stahlkern verstärkt und sorgen für  
Sicherheit beim Spielen.

**Play units | Spielanlagen**



**Swings | Schaukeln**



**Hammocks and Seesaws | Hängematten und Wippe**



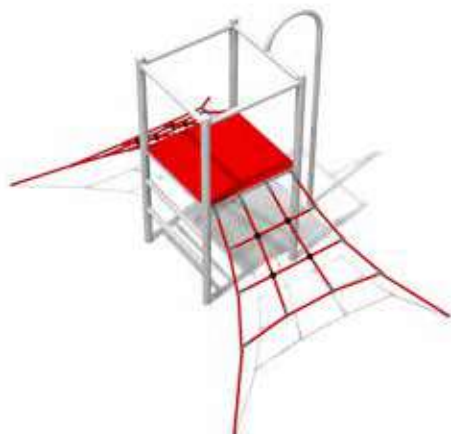

**CACTUS 1**  
GM41413-T



**CACTUS 2**  
GM41411-T

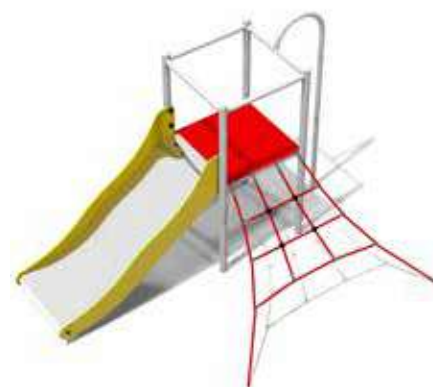







**CACTUS 3**  
GM41412-T



**BLUEBELL**  
GK-PA-103



**BERGAMOT**  
GK-PA-101

								
<b>CACTUS 1</b>	GM41413-T	2,93 x 1,84 x 1,80	5,97 x 4,83	0,90	3+	4		
<b>CACTUS 2</b>	GM41411-T	2,68 x 0,81 x 1,80	6,20 x 3,79	0,90	3+	2		
<b>JASMINE</b>	GM41423-T	3,63 x 2,93 x 1,80	6,66 x 6,44	1,80	3+	8		
<b>CACTUS 3</b>	GM41412-T	2,77 x 1,87 x 1,80	6,26 x 4,88	0,90	3+	3		
<b>DAISY</b>	GM424401-T	4,33 x 2,25 x 1,80	7,38 x 5,75	0,90	3+	7		
<b>BERGAMOT</b>	GK-PA-101	3,77 x 3,29 x 2,86	6,77 x 6,79	0,90	3+	7		
<b>MARIGOLD</b>	GK-PA-102	6,98 x 2,85 x 2,86	10,98 x 5,85	1,26	3+	6		
<b>BLUEBELL</b>	GK-PA-103	5,83 x 4,24 x 3,22	9,31 x 7,21	1,95	3+	13		



**MARIGOLD**  
GK-PA-102



**JASMINE**  
GM41423-T

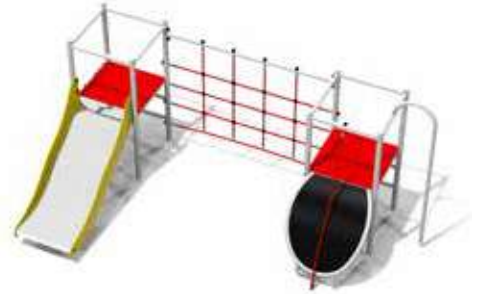

**DAISY**  
GM424401-T





**LILAC**  
GK-PA-105



**PANSY**  
GK-PA-106



**POPPY**  
GK-PA-104



**PETUNIA**  
GK-PA-107



**CAMELLIA**  
GM424402-T



**GERBERA**  
GM444401-T



<b>LILAC</b>	GK-PA-105	5,97 x 4,58 x 3,22	9,47 x 7,58	1,95	3+	13
<b>PANSY</b>	GK-PA-106	6,98 x 4,28 x 2,86	10,98 x 7,28	1,95	3+	12
<b>POPPY</b>	GK-PA-104	6,15 x 5,00 x 2,86	9,65 x 8,00	1,50	3+	9
<b>PETUNIA</b>	GK-PA-107	6,78 x 4,72 x 3,22	10,28 x 7,82	1,95	3+	18
<b>CAMELLIA</b>	GM424402-T	4,70 x 3,09 x 2,86	8,19 x 6,07	2,00	3+	10
<b>GERBERA</b>	GM444401-T	5,83 x 5,42 x 3,22	8,84 x 8,90	2,00	3+	20
<b>MARIGOLD</b>	GK-PA-102	6,98 x 2,85 x 2,86	10,98 x 5,85	1,26	3+	6
<b>BLUEBELL</b>	GK-PA-103	5,83 x 4,24 x 3,22	9,31 x 7,21	1,95	3+	13











**MARS 2**  
IS-RO-301S



**MOON**  
IS-RO-304



**ORION 3**  
IS-RO-302BS

						
<b>MARS 1</b>	IS-RO-301S	2,65 x 1,84 x 2,26	1,75 x 7,35	1,25	3+	1
<b>MARS 2</b>	IS-RO-301B	2,65 x 1,84 x 2,26	1,75 x 7,35	1,06	3+	1
<b>MOON</b>	IS-RO-304	2,90 x 1,84 x 2,26	1,85 x 7,35	1,21	3+	2
<b>NEPTUNE 1</b>	IS-RO-303S	6,19 x 1,84 x 2,26	5,35 x 7,35	1,25	3+	4
<b>NEPTUNE 2</b>	IS-RO-303B	6,19 x 1,84 x 2,26	5,35 x 7,35	1,21	3+	4
<b>NEPTUNE 3</b>	IS-RO-303BS	6,19 x 1,84 x 2,26	5,35 x 7,35	1,25	3+	4
<b>ORION 1</b>	IS-RO-302S	3,70 x 1,84 x 2,26	3,00 x 7,35	1,25	3+	2
<b>ORION 2</b>	IS-RO-302B	3,70 x 1,84 x 2,26	3,00 x 7,35	1,06	3+	2
<b>ORION 3</b>	IS-RO-302BS	3,70 x 1,84 x 2,26	3,00 x 7,35	1,25	3+	2

**NEPTUNE 3**  
IS-RO-303BS





**SUNON 1N**  
IS-RO-351-N









**SUNON 1S**  
IS-RO-351-S



**SUNON 2NS**  
IS-RO-352-NS



**SUNON 2BS**  
IS-RO-352-BS

						
<b>SUNON 1S</b>	IS-RO-351-S	1,95 x 0,19 x 1,68	6,54 x 1,75	0,99	3+	1
<b>SUNON 1N</b>	IS-RO-351-N	2,60 x 1,06 x 1,68	6,20 x 2,34	1,09	3+	1
<b>SUNON 2BS</b>	IS-RO-352-BS	3,80 x 0,29 x 1,68	6,54 x 3,60	0,99	3+	2
<b>SUNON 2NS</b>	IS-RO-352-NS	4,45 x 1,06 x 1,68	6,54 x 4,22	1,10	3+	2
<b>TULIP</b>	GM1652-T	2,80 x 0,51 x 0,90	2,51 x 4,80	0,90	3+	2
<b>IRIS 1</b>	IS-PA-201	3,04 x 0,38 x 0,75	5,04 x 2,38	0,95	3+	2
<b>IRIS 2</b>	IS-PA-202	3,04 x 0,38 x 0,75	5,04 x 2,38	0,95	3+	4
<b>LINO 1</b>	IS-HA-001	3,40 x 0,90 x 1,30	6,40 x 3,90	0,48	3+	1
<b>LINO 2</b>	IS-HA-002	6,70 x 0,90 x 1,30	9,70 x 3,90	0,48	3+	2
<b>LINO 3</b>	IS-HA-003	10,00 x 0,90 x 1,30	13,00 x 3,90	0,48	3+	3



**TULIP**  
GM1652-T



**IRIS 2**  
IS-PA-202



**IRIS 1**  
IS-PA-201



**LINO 1**  
IS-HA-001



**LINO 2**  
IS-HA-002

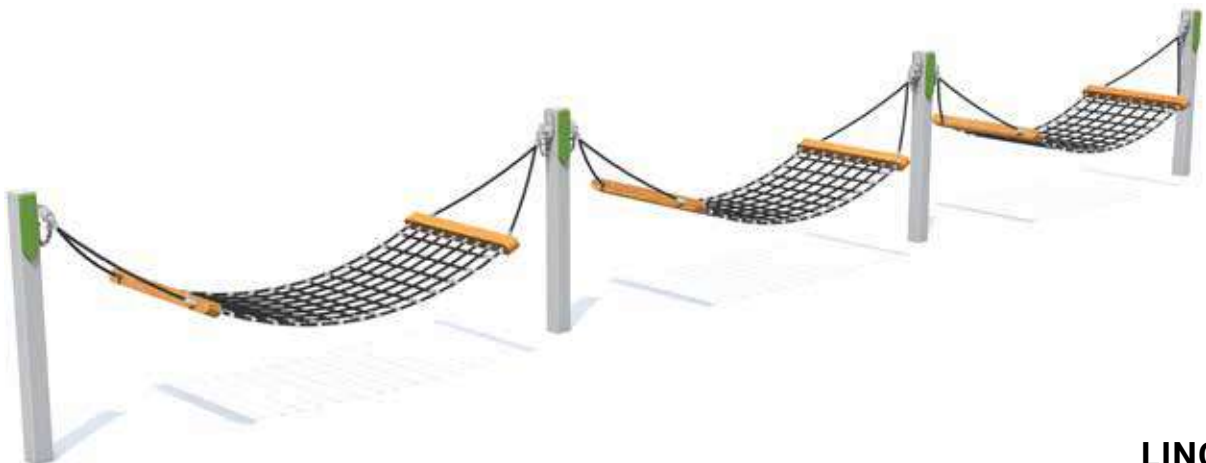

**LINO 3**  
IS-HA-003

AKRA





Bridges and rope tunnels made of strong polyamide rope.

Kletterbrücken und Tunnel sind aus starkem Polyamid-Seil gefertigt.

Tunnels made of polypropylene.

Tunnel aus Polypropylen.

Funny graphics on roofs and side panels.

Fröhliche Kindermotive auf den Dächern und Seitenpaneelen.



Structure made of stable, metal profiles.

Stabile Konstruktion aus Stahl.

Colorful polyethylene slides are protected against heating.

Bunte PE-Rutschen werden nie heiß.

Extremely durable HPL platform board is equipped with non-slip structure that ensures safety and limits possibility of uncontrolled slippage during play.

Langlebige HPL-Platte mit einer rutschfesten Struktur gewährleistet die Sicherheit und begrenzt die Möglichkeit des unkontrollierten Rutschens während des Spiels.

**AVELO**

For children 3-6 years old

Für 3-6 jährige Kinder

**PIRO**

For children under 3 years old

Für Kinder unter 3 Jahren





**AVELO 4-2**  
BO-AK-542









**AVELO 4-3**  
BO-AK-543



**AVELO 3-5**  
BO-AK-535



**AVELO 3-3**  
BO-AK-533

						
<b>AVELO 4-2</b>	BO-AK-542	5,37 x 4,64 x 3,11	8,87 x 8,14	1,94	3+	12
<b>AVELO 4-3</b>	BO-AK-543	7,64 x 5,37 x 3,11	11,64 x 8,87	1,94	3+	12
<b>AVELO 3-5</b>	BO-AK-535	5,61 x 3,11 x 3,11	8,61 x 6,61	1,20	3+	10
<b>AVELO 3-3</b>	BO-AK-533	4,95 x 4,07 x 3,11	7,95 x 8,07	1,20	3+	9
<b>AVELO 3-4</b>	BO-AK-534	5,37 x 3,24 x 3,11	8,87 x 6,24	1,20	3+	11
<b>AVELO 2-4</b>	BO-AK-524	4,75 x 3,42 x 3,11	8,75 x 6,42	1,20	3+	6



**AVELO 3-4**  
BO-AK-534



**AVELO 2-4**  
BO-AK-524





**AVELO 2-3**  
BO-AK-523



**AVELO 2-5**  
BO-AK-525



**AVELO 1-2**  
BO-AK-512



**AVELO 1-3**  
BO-AK-513



**PIRO 4-1**  
BO-AK-541



**PIRO 3-1**  
BO-AK-531



<b>AVELO 2-3</b>	BO-AK-523	4,07 x 3,42 x 3,11	8,07 x 6,42	1,94	3+	4
<b>AVELO 2-5</b>	BO-AK-525	4,79 x 1,31 x 3,11	8,29 x 4,31	1,20	3+	5
<b>AVELO 1-2</b>	BO-AK-512	2,82 x 0,78 x 1,72	6,32 x 3,78	0,90	3+	2
<b>AVELO 1-3</b>	BO-AK-513	2,75 x 1,82 x 3,11	6,25 x 4,82	1,20	3+	2
<b>PIRO 4-1</b>	BO-AK-541	4,83 x 2,99 x 2,25	8,83 x 5,99	1,33	1+	9
<b>PIRO 3-2</b>	BO-AK-532	4,27 x 2,99 x 2,25	7,77 x 5,99	1,33	1+	6
<b>PIRO 3-1</b>	BO-AK-531	6,31 x 0,92 x 2,25	9,83 x 3,93	0,59	1+	6
<b>PIRO 2-1</b>	BO-AK-521	4,27 x 0,92 x 2,25	7,77 x 3,92	0,59	1+	3
<b>PIRO 2-2</b>	BO-AK-522	3,93 x 1,29 x 2,25	7,43 x 4,29	0,59	1+	4
<b>PIRO 1-1</b>	BO-AK-511	2,23 x 0,92 x 2,25	5,73 x 3,93	0,59	1+	2



**PIRO 3-2**  
BO-AK-532



**PIRO 2-1**  
BO-AK-521



**PIRO 2-2**  
BO-AK-522



**PIRO 1-1**  
BO-AK-511



 Robinia





**Wood type ROBINIA**

Beams approximately 16 cm thick. The hardwood is very durable and thus does not require frequent repairs. The natural appearance makes play even more attractive.

**Robinienholz**

Balken mit einer Dicke von ca. 16 cm. Das Hartholz ist sehr langlebig und erfordert daher keine häufigen Reparaturen. Das natürliche Aussehen macht das Spielen noch attraktiver.

**HDPE Board**

Decorations made from colorful 15mm thick board. They give an attractive appearance reminiscent of forest motifs.

**HDPE-Platte**

Dekorationen aus einer 15 mm dicken, bunten Platte. Sie verleihen ein attraktives Aussehen, das an Waldmotive erinnert.

**Wood Connectors**

All wooden elements are joined together with stainless connectors.

**Holzverbinder**

Alle Holzelemente sind mit rostfreien Verbindern miteinander verbunden.

**Ropes**

6-strand ropes with an internal steel core for enhanced durability.

**Seile**

6-strängige Seile mit einem inneren Stahldrahtkern für erhöhte Haltbarkeit.

**Stainless Steel**

The slide and bars are made of stainless steel. The elements are durable and very aesthetically pleasing

**Edelstahl**

Die Rutsche und Stangen sind aus Edelstahl gefertigt. Die Elemente sind langlebig und sehr ästhetisch.



**The hardwood ROBINIA is very durable and therefore does not require frequent repairs.**

**Hartholz ROBINIA ist sehr langlebig und erfordert daher keine häufigen Reparaturen.**

**The natural appearance of the wood ensures that play is even more attractive.**

**Das natürliche Aussehen des Holzes sorgt dafür, dass das Spielen noch attraktiver wird.**

**The wood we use is sourced from plantations with FSC certification.**

**Das von uns verwendete Holz stammt aus Plantagen mit FSC-Zertifizierung.**





**ROBINIA 1**  
02-ROB-700



**ROBINIA 2**  
02-ROB-701



**ROBINIA 3**  
02-ROB-702



**ROBINIA 4**  
02-ROB-703



<b>ROBINIA 1</b>	02-ROB-700	3,75 x 4,20 x 4,25	7,25 x 7,20	90,00	3-12	10
<b>ROBINIA 2</b>	02-ROB-701	3,60 x 4,42 x 4,25	6,60 x 7,92	120,00	3-12	10
<b>ROBINIA 3</b>	02-ROB-702	5,25 x 9,00 x 4,80	8,75 x 12,00	200,00	3-12	16
<b>ROBINIA 4</b>	02-ROB-703	9,40 x 6,42 x 4,50	13,00 x 9,92	210,00	3-12	25
<b>ROBINIA 5</b>	02-ROB-200-N	2,38 x 3,21 x 2,48	7,50 x 2,35	137,00	3-12	2
<b>ROBINIA 8</b>	02-ROB-203-BS	2,38 x 3,89 x 2,48	7,50 x 3,17	134,00	3-12	2
<b>ROBINIA 9</b>	02-ROB-204-NS	2,38 x 4,46 x 2,48	7,50 x 5,25	137,00	3-12	2
<b>ROBINIA 11</b>	02-ROB-650	0,73 x 3,00 x 1,05	2,73 x 4,91	90,00	3-12	2
<b>ROBINIA 12</b>	02-ROB-600	0,32 x 0,95 x 0,86	2,32 x 3,55	58,00	1-12	1



**ROBINIA 5**  
02-ROB-200-N



**ROBINIA 8**  
02-ROB-203-BS



**ROBINIA 9**  
02-ROB-204-NS

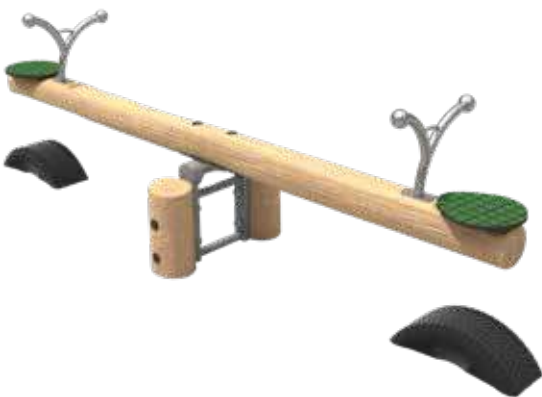

**ROBINIA 11**  
02-ROB-650



**ROBINIA 12**  
02-ROB-600



**ROBINIA 13**  
02-ROB-1100



**ROBINIA 14**  
BO-DR-102



**ROBINIA 21**  
02-ROB-1103



**ROBINIA 18**  
02-ROB-706



**ROBINIA 19**  
02-ROB-707

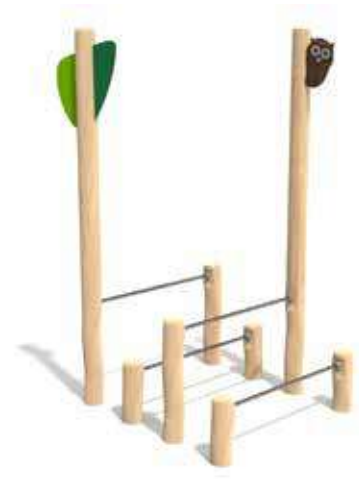

**ROBINIA 20**  
02-ROB-708



<b>ROBINIA 13</b>	02-ROB-1100	2,75 x 2,75 x 0,60	5,75 x 5,75	60,00	3-12	8
<b>ROBINIA 14</b>	02-ROB-1101	2,52 x 2,52 x 4,80	5,86 x 5,86	99,00	3-12	12
<b>ROBINIA 15</b>	02-ROB-704	9,87 x 4,60 x 4,45	12,87 x 8,30	201,00	3-12	18
<b>ROBINIA 16</b>	02-ROB-1102	5,33 x 5,33 x 4,80	8,47 x 8,47	170,00	3-12	25
<b>ROBINIA 17</b>	02-ROB-705	2,75 x 9,60 x 4,80	5,75 x 12,60	80,00	3-12	20
<b>ROBINIA 18</b>	02-ROB-706	1,45 x 3,60 x 3,60	4,45 x 6,60	60,00	3-12	8
<b>ROBINIA 19</b>	02-ROB-707	3,80 x 0,45 x 4,80	6,80 x 3,45	150,00	3-12	3
<b>ROBINIA 20</b>	02-ROB-708	2,20 x 1,85 x 3,60	5,20 x 4,85	100,00	3-12	4
<b>ROBINIA 21</b>	02-ROB-1103	2,05 x 3,45 x 1,91	5,45 x 6,85	180,00	3-12	4

**ROBINIA 17**  
02-ROB-705

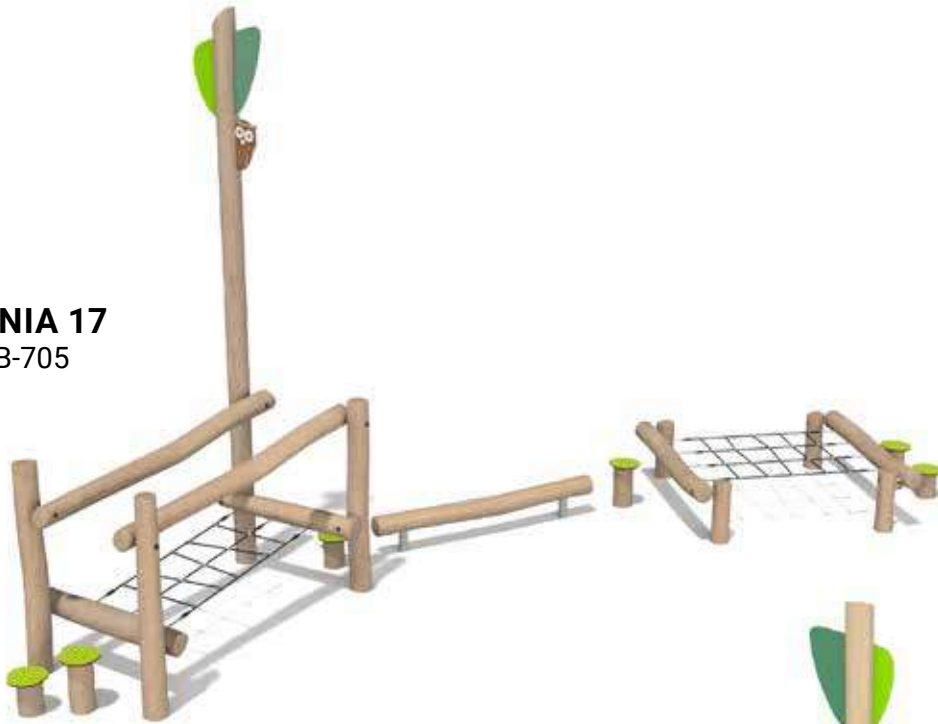

**ROBINIA 16**  
02-ROB-1102

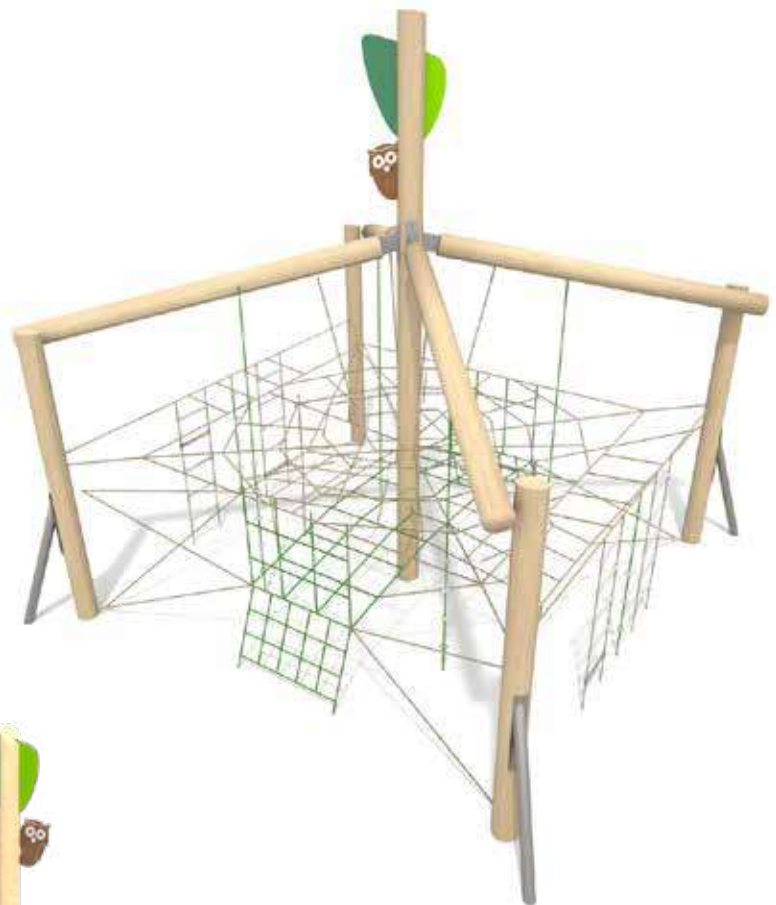

**ROBINIA 15**  
02-ROB-704

# dog agility



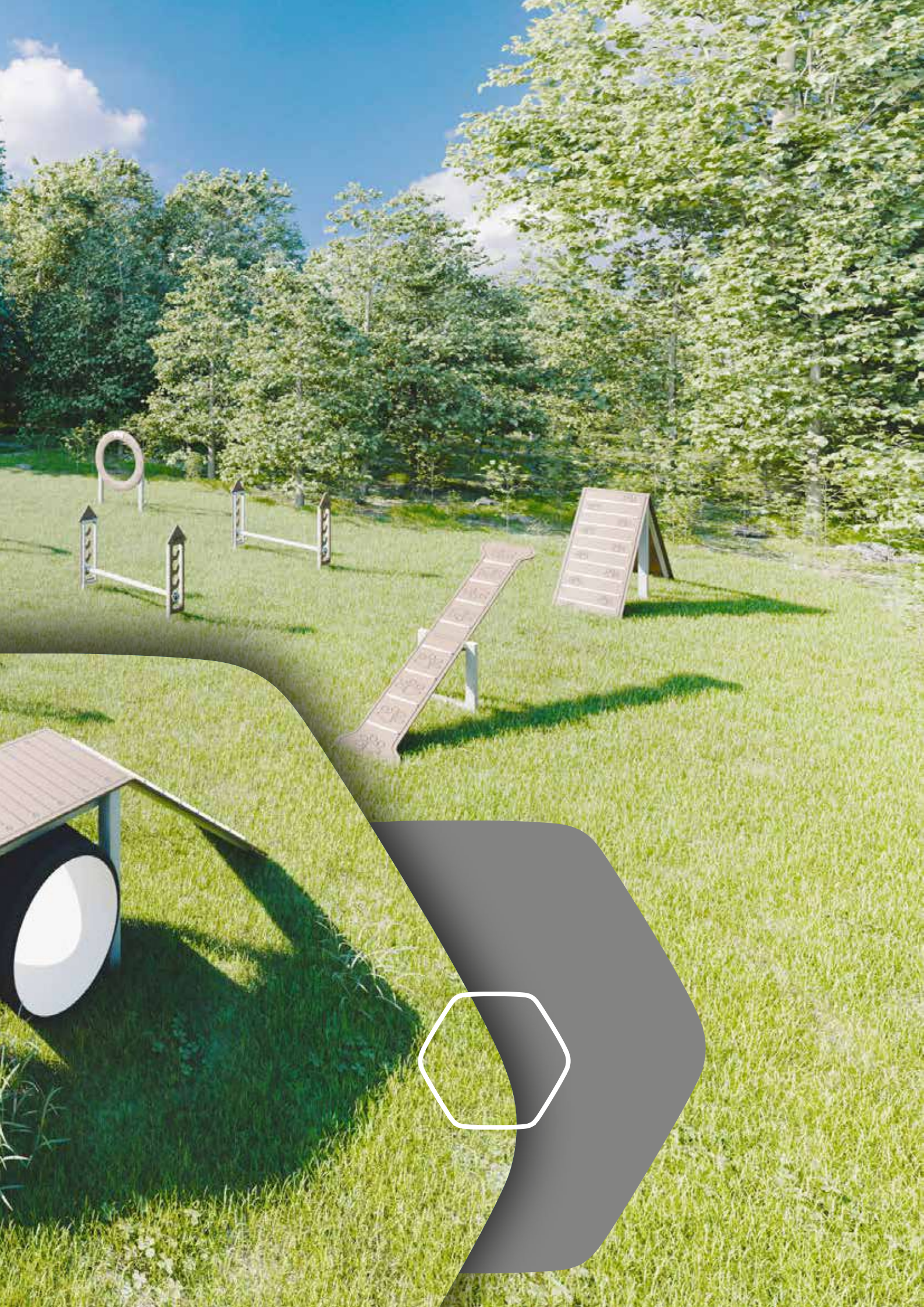

## DOG AGILITY Series

Especially for all dogs, we have created the DOG AGILITY series. Thanks to it, you can create a fantastic space where dogs can play and exercise. Additionally, dog owners meet each other and have a great time together.

We have made sure that our offer includes most of the exercises and obstacles that such a facility should be equipped with.

## Serie DOG AGILITY

Speziell für alle Hunde haben wir die Serie DOG AGILITY entwickelt. So kann ein fantastischer Bereich geschaffen werden, in dem Hunde spielen und trainieren können. Zusätzlich treffen sich die Hundebesitzer, um gemeinsam eine schöne Zeit zu verbringen.

Wir haben darauf geachtet, dass unser Angebot die meisten Übungen und Hindernisse umfasst, die eine solche Anlage unbedingt haben sollte.







**DOG AGILITY 1**  
01-DA-3900



**DOG AGILITY 2**  
01-DA-3901



**DOG AGILITY 3**  
01-DA-3902



**DOG AGILITY 4**  
01-DA-3903



**DOG AGILITY 5**  
01-DA-3904



**DOG AGILITY 6**  
01-DA-3905



<b>DOG AGILITY 1</b>	01-DA-3900	3,85 x 0,55 x 1,18
<b>DOG AGILITY 2</b>	01-DA-3901	3,40 x 1,47 x 2,35
<b>DOG AGILITY 3</b>	01-DA-3902	1,32 x 1,47 x 1,67
<b>DOG AGILITY 4</b>	01-DA-3903	1,98 x 1,47 x 1,67
<b>DOG AGILITY 5</b>	01-DA-3904	3,15 x 0,55 x 0,79
<b>DOG AGILITY 6</b>	01-DA-3905	1,05 x 0,10 x 1,37
<b>DOG AGILITY 7</b>	01-DA-3906	1,44 x 0,71 x 0,45
<b>DOG AGILITY 8</b>	01-DA-3907	3,20 x 0,90 x 0,66
<b>DOG AGILITY 9</b>	01-DA-3908	2,36 x 0,55 x 1,18
<b>DOG AGILITY 10</b>	01-DA-3909	3,64 x 0,35 x 0,95
<b>DOG AGILITY 11</b>	01-DA-3910	4,18 x 3,15 x 2,20
<b>DOG AGILITY 12</b>	01-DA-3911	2,4 x 0,10 x 0,89
<b>DOG AGILITY 13</b>	01-DA-3912	0,75 x 0,75 x 0,31
<b>DOG AGILITY 14</b>	01-DA-3913	3,00 x 0,50 x 0,72
<b>DOG AGILITY 15</b>	01-DA-3914	0,75 x 0,75 x 0,18
<b>DOG AGILITY 16</b>	01-DA-3915	1,23 x 0,32 x 1,00
<b>DOG AGILITY 17</b>	01-DA-3916	1,00 x 1,00 x 0,46



**DOG AGILITY 7**  
01-DA-3906



**DOG AGILITY 8**  
01-DA-3907



**DOG AGILITY 9**  
01-DA-3908



**DOG AGILITY 10**  
01-DA-3909



**DOG AGILITY 11**  
01-DA-3910



**DOG AGILITY 12**  
01-DA-3911



**DOG AGILITY 13**  
01-DA-3912



**DOG AGILITY 14**  
01-DA-3913



**DOG AGILITY 15**  
01-DA-3914



**DOG AGILITY 16**  
01-DA-3915



**DOG AGILITY 17**  
01-DA-3916



## SPEED Series – Obstacle Courses

A challenge to complete with time measurement. The courses can be equipped with an unlimited number of obstacles. The obstacles are overcome by weaving through them in a slalom, running, hanging, climbing, crawling under, or jumping over. It's an excellent way to exercise and compete. The START/STOP panel measures the time it takes to complete the obstacle course.

## SPEED Serie – Hindernisparcours

Eine Herausforderung mit Zeitmessung! Die Parcours können mit einer unbegrenzten Anzahl von Hindernissen ausgestattet werden. Die Hindernisse werden durch Slalomlaufen, Rennen, Hängen, Klettern, Kriechen oder Springen überwunden. Es ist eine hervorragende Möglichkeit, sich zu bewegen und miteinander zu konkurrieren. Die START/STOP-Tafel misst die Zeit für den gesamten Hindernisparcours.

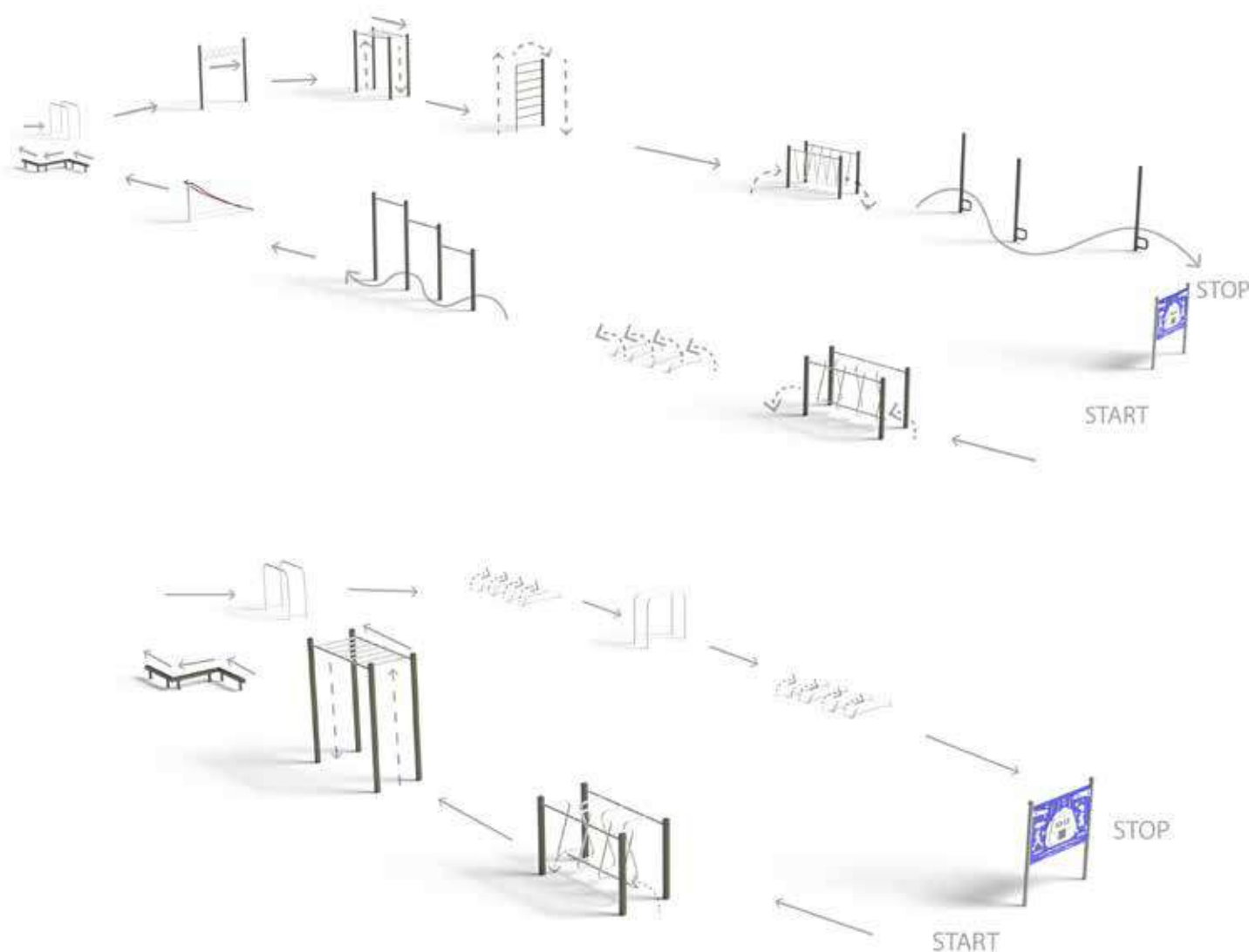



**START&STOP sensory board**  
IS-TA-114

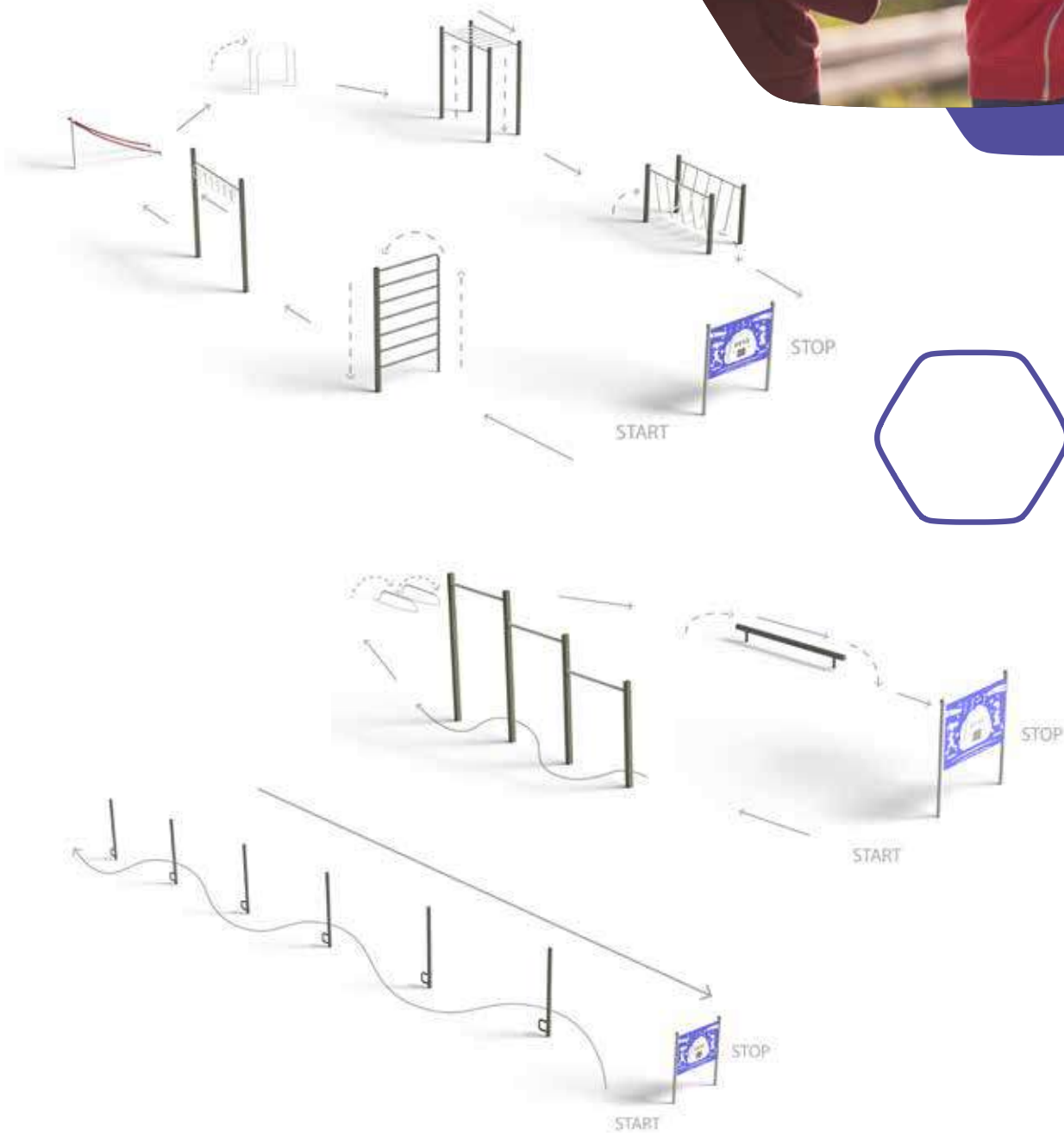

**FITNESS**



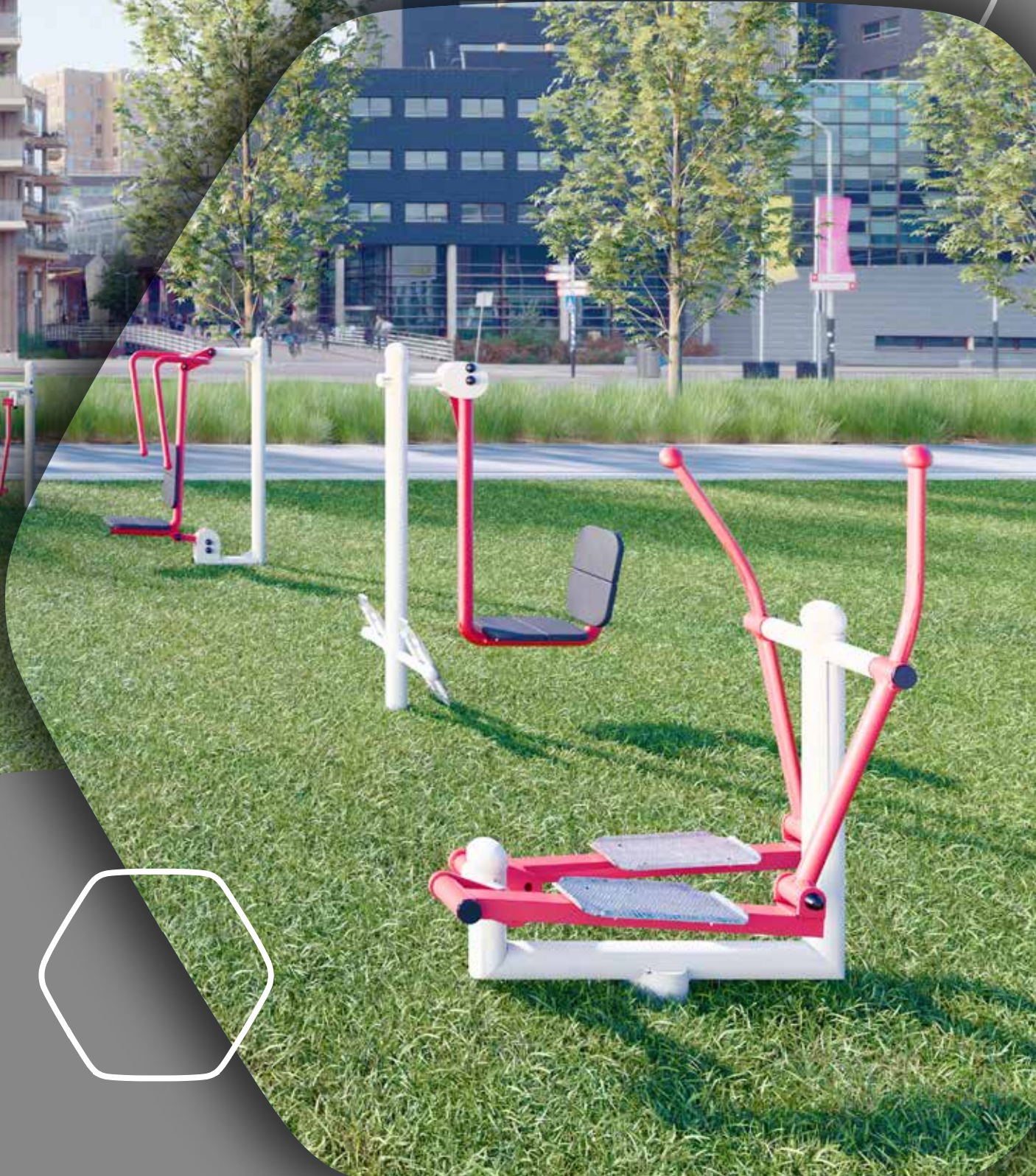

Healthy body, healthy mind. Experts recommend a lot of exercise in the fresh air in order to stay healthy and fit for as long as possible. Let's create attractive zones for fitness and meetings.

Körperliche Aktivität ist ein wichtiger Bestandteil unseres Lebens. Besonders die Bewegung an der frischen Luft ist eine Wohltat für Körper, Geist und Seele. Mit unserer Hilfe schaffen Sie attraktive und langlebige Outdoor Bereiche für Training und Treffen mit Freunden.



For younger and elder users.

Geeignet für Jugendliche und Senioren.

Highest quality.

Höchste Qualität.

Intuitive exercising.

Intuitives Training.

Comfortable seats.

Komfortable Rückenlehne und Sitzfläche.

Full range of fitness equipment.

Große Auswahl an Geräten.

Durable.

Vandalismus beständig.

Reliable.

Solid & Langlebig.



### Comfortable seats make exercising more pleasant

Dank der komfortablen Sitzen wird das Training noch angenehmer



Seats covered by PU material.

Die Sitzfläche und Rückenlehne aus bequemem, flexiblem PU-Material.

## Create FITNESS zone

We provide ready-made designs of FITNESS zones containing an example of arrangement of the exercise device. It's perfect for people who want to spend time actively.

Wir bieten vorgefertigte Projekte von öffentlichen FITNESS-Bereichen an. Hier finden Sie die beispielhafte Anordnung der Trainingsgeräten.



We assist in the selection of devices.  
Unterstützung bei der Produktwahl.

We help in any project modification.  
Unterstützung bei der Projektanpassung.

Well considered layouts.  
Professionelle Geräteanordnung.

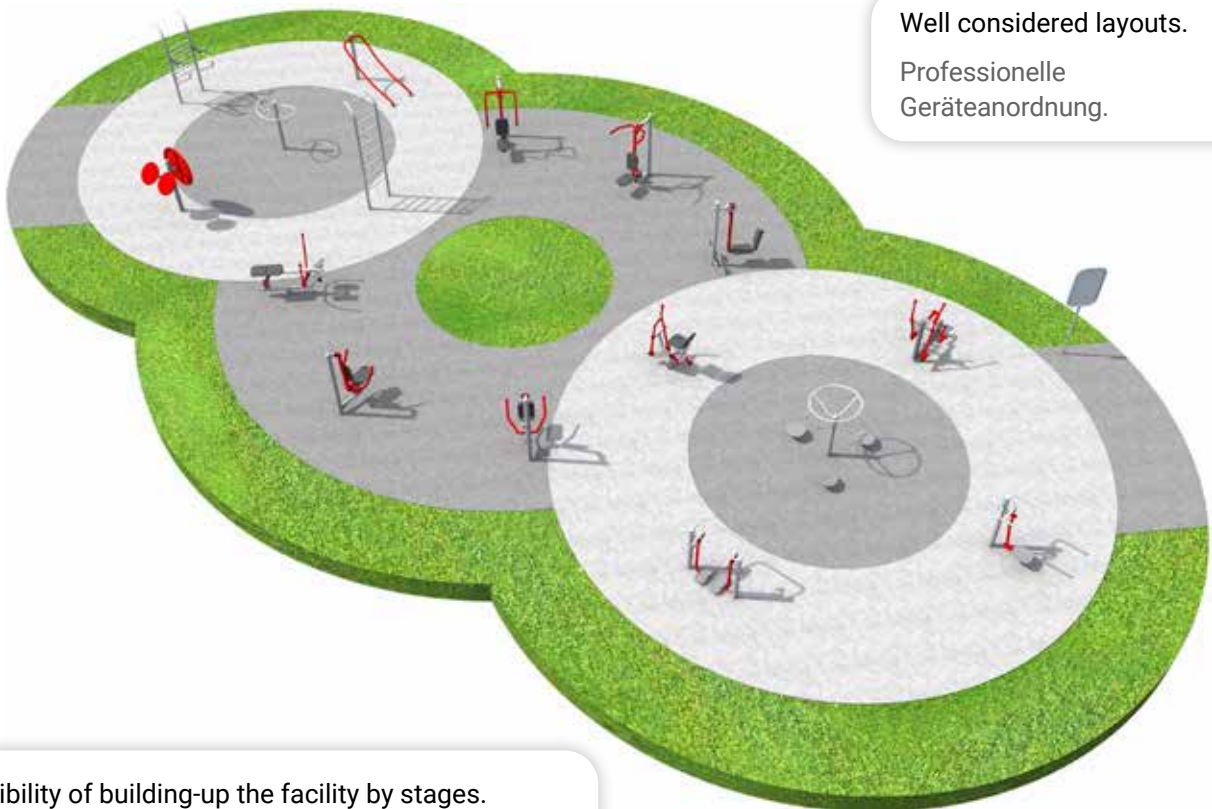

Possibility of building-up the facility by stages.  
Den fertigen Projekt kann man Schrittweise erweitern.

Accurate descriptions and instructions.  
Detaillierte Beschreibungen und Anweisungen.

CAD files for designing.  
CAD-Entwürfe.



**SHOULDER PRESS**  
KS-FS-014



**CHEST PULL**  
KS-FS-011



**CHEST PRESS**  
KS-FS-013



**SHOULDER PULL**  
KS-FS-012



**LEG PRESS I**  
**BEINPRESSE I**  
KS-FS-002



**DOUBLE LEG PRESS I**  
**DOPPELTE BEINPRESSE I**  
KS-FD-005



**DOUBLE CHEST PRESS**  
KS-FD-011



<b>SHOULDER PRESS</b>	KS-FS-014	1,05 x 0,70 x 1,70	4,05 x 3,70
<b>CHEST PULL</b>	KS-FS-011	1,27 x 0,74 x 1,60	4,27 x 3,74
<b>CHEST PRESS</b>	KS-FS-013	1,26 x 0,70 x 1,60	3,26 x 3,70
<b>SHOULDER PULL</b>	KS-FS-012	2,38 x 0,70 x 1,70	5,38 x 3,70
<b>LEG PRESS I</b>	KS-FS-002	1,27 x 0,65 x 1,65	4,27 x 3,66
<b>DOUBLE LEG PRESS I</b>	KS-FD-005	1,64 x 0,65 x 1,65	4,64 x 3,65
<b>DOUBLE CHEST PRESS</b>	KS-FD-011	2,43 x 0,74 x 1,60	5,43 x 3,74
<b>CHEST PRESS + CHEST PULL</b>	KS-FD-003	2,43 x 0,74 x 1,60	5,43 x 3,74
<b>SHOULDER PRESS + CHEST PRESS</b>	KS-FD-010	2,22 x 0,74 x 1,70	5,22 x 3,74
<b>LEG PRESS + CHEST PRESS</b>	KS-FD-012	2,38 x 0,7 x 1,65	5,38 x 3,70 m



**CHEST PRESS  
+ CHEST PULL**  
KS-FD-003



**LEG PRESS  
+ CHEST PRESS**  
KS-FD-012



**SHOULDER PRESS  
+ CHEST PRESS**  
KS-FD-010





**TWISTER**  
KS-FS-028



**PENDULUM  
PENDEL**  
KS-FS-016



**PENDULUM + TWISTER  
PENDEL + TWISTER**  
KS-FD-007

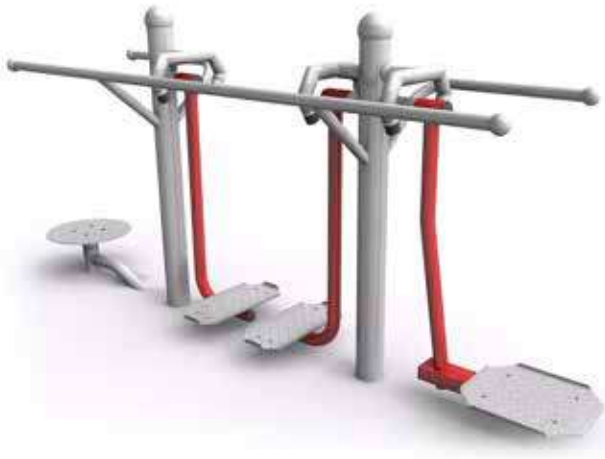

**TWISTER + RUNNER + PENDULUM  
TWISTER + LÄUFER + PENDEL**  
KS-FT-001



**DOUBLE  
SHOULDER PULL**  
KS-FD-002



<b>TWISTER</b>	KS-FS-028	0,83 x 0,72 x 1,34	3,83 x 3,72
<b>PENDULUM</b>	KS-FS-016	0,83 x 0,65 x 1,32	3,83 x 3,65
<b>PENDULUM + TWISTER</b>	KS-FD-007	1,35 x 0,74 x 1,54	4,35 x 3,74
<b>TWISTER+RUNNER+PENDULUM</b>	KS-FT-001	2,38 x 0,65 x 1,60	5,38 x 3,65
<b>DOUBLE SHOULDER PULL</b>	KS-FD-002	2,12 x 0,74 x 1,64	5,12 x 3,74
<b>SHOULDER PRESS + SHOULDER PULL</b>	KS-FD-004	2,35 x 0,74 x 1,70	5,35 x 3,74
<b>TRIPLE TWISTER</b>	KS-FD-008	1,77 x 1,55 x 1,25	4,43 x 4,65
<b>TAI-CHI</b>	KS-FS-021	1,00 x 0,86 x 1,68	4,00 x 3,86



**SHOULDER PRESS  
+ SHOULDER PULL**  
KS-FD-004

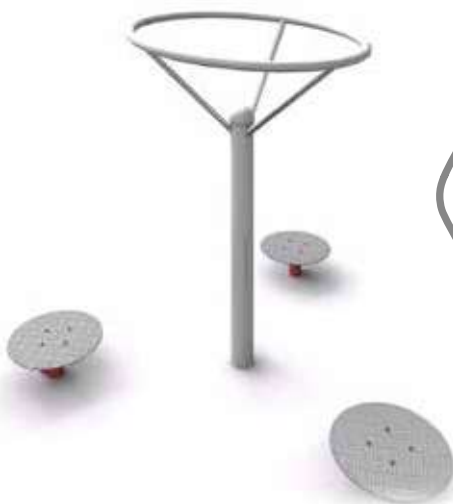

**TRIPLE TWISTER  
DREIFACHER TWI-  
STER**  
KS-FD-008



**TAI-CHI**  
KS-FS-021



<b>ROWING MACHINE</b>	KS-FS-015	1,42 x 0,97 x 1,25	4,42 x 3,97
<b>HORSE RIDER</b>	KS-FS-005	1,25 x 0,71 x 1,23	4,25 x 3,71
<b>BIKE II</b>	KS-FS-007	0,89 x 0,50 x 1,25	3,84 x 3,50
<b>BIKE I</b>	KS-FS-006	0,93 x 0,50 x 1,32	3,93 x 3,50
<b>RUNNER</b>	KS-FS-017	1,00 x 0,54 x 1,40	4,00 x 3,54
<b>ORBITREK</b>	KS-FS-001	1,35 x 0,62 x 1,60	4,35 x 3,62
<b>SKI RUNNER</b>	KS-FS-008	1,00 x 0,57 x 1,42	4,00 x 3,57
<b>DOUBLE SKI RUNNER</b>	KS-FD-006	1,91 x 0,57 x 1,42	4,91 x 3,57



**ROWING MACHINE**  
**RUDERGERÄT**  
 KS-FS-015



**HORSE RIDER**  
**REITER**  
 KS-FS-005



**BIKE II**  
 KS-FS-007



**BIKE I**  
 KS-FS-006



**RUNNER**  
**LÄUFER**  
 KS-FS-017



**DOUBLE SKI RUNNER**  
**DOPPELTER SKILÄUFER**  
 KS-FD-006



**SKI RUNNER**  
**SKILÄUFER**  
 KS-FS-008



**ORBITREK**  
**CROSSTRAINER**  
 KS-FS-001



**BENCH  
BANK**  
KS-FS-018



**BACK STRAIGHTENER  
RÜCKENSTRECKER**  
KS-FS-019



**PUSH-UP TRAINER  
LIEGESTÜTZTRAINER**  
KS-FS-022



**RUNNING TRACK  
LAUFBAND**  
KS-FS-023



**STRETCHING TRAINER  
STRETCHING-GERÄT**  
KS-FS-020



**HANDRAILS  
SPOSSENWAND**  
KS-FS-027



<b>BENCH</b>	KS-FS-018	1,34 x 0,41 x 0,45	4,50 x 3,50
<b>BACK STRAIGHTENER</b>	KS-FS-019	0,63 x 0,63 x 0,82	3,70 x 3,70
<b>PUSH-UP TRAINER</b>	KS-FS-022	1,72 x 0,74 x 1,37	4,80 x 3,80
<b>RUNNING TRACK</b>	KS-FS-023	1,25 x 0,57 x 1,41	4,25 x 3,57
<b>STRETCHING TRAINER</b>	KS-FS-020	0,83 x 0,83 x 1,27	3,85 x 3,58
<b>HANDRAILS</b>	KS-FS-027	0,96 x 0,72 x 2,05	3,96 x 3,72
<b>LADDER I</b>	KS-FS-025	0,65 x 0,27 x 1,89	4,15 x 3,77
<b>LADDER III</b>	KS-FS-030	0,82 x 0,65 x 1,89	3,82 x 3,65
<b>LADDER II</b>	KS-FS-026	0,65 x 0,27 x 2,69	5,65 x 5,27
<b>LADDER IV</b>	KS-FS-031	0,82 x 0,65 x 2,69	3,82 x 3,65



**LADDER I**  
**LEITER I**  
KS-FS-025



**LADDER III**  
**LEITER III**  
KS-FS-030



**LADDER II**  
**LEITER II**  
KS-FS-026



**LADDER IV**  
**LEITER IV**  
KS-FS-031



STREET  
**WORKOUT**





Street Workout devices are the perfect complement to an outdoor gym. Calisthenics develops all muscle groups and strengthens entire body. People of all ages can perform this type of exercise. Street Workout devices can be combined in many different ways to create one-of-a-kind training circuits for each part of the body.

Street-Workout-Geräte sind die ideale Ergänzung für ein Outdoor-Fitnessstudio, sie ermöglichen die Entwicklung einzelner Muskelgruppen und die allgemeine Körperstärkung. Die Geräte sind an alle Altersgruppen und Leistungsstufen angepasst. Die Anlagen der Street Workout Serie können beliebig kombiniert werden, um einzigartige Trainingssets für alle Körperteile zu schaffen.

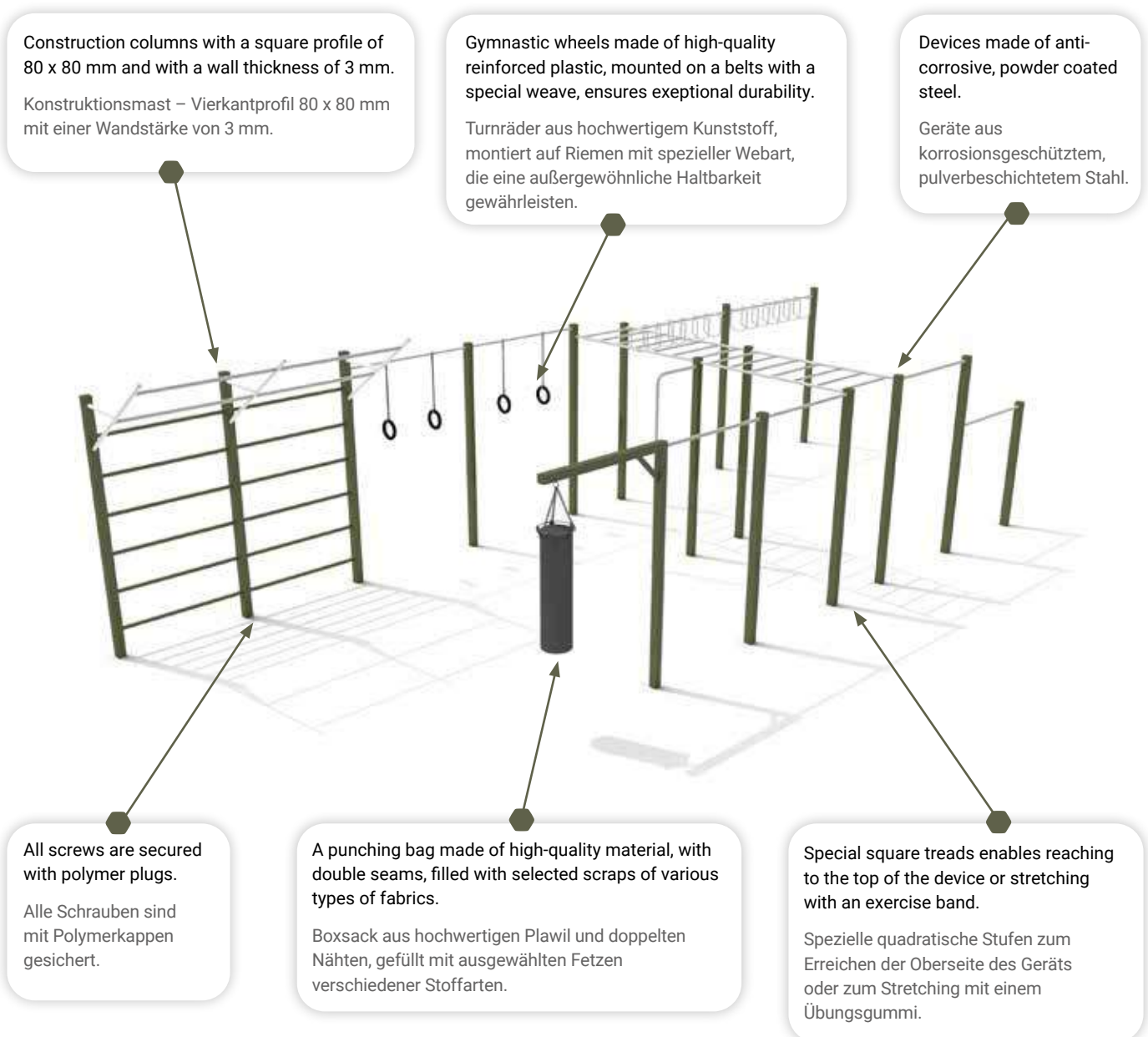



**STREET WORKOUT 1**  
KS-SW-19







**STREET WORKOUT 2**  
KS-SW-20



**STREET WORKOUT 3**  
KS-SW-21



**STREET WORKOUT 4**  
KS-SW-22

	...			
<b>STREET WORKOUT 1</b>	KS-SW-19	1,40 x 1,40 x 2,50	5,40 x 5,40	1,40
<b>STREET WORKOUT 2</b>	KS-SW-20	2,16 x 1,00 x 2,50	5,16 x 4,00	1,40
<b>STREET WORKOUT 3</b>	KS-SW-21	2,42 x 2,16 x 2,50	5,42 x 5,16	1,40
<b>STREET WORKOUT 4</b>	KS-SW-22	3,48 x 1,40 x 2,50	7,48 x 5,40	1,40



**STREET WORKOUT 5**  
KS-SW-23



**STREET WORKOUT 6**  
KS-SW-24



**STREET WORKOUT 7**  
KS-SW-25



**STREET WORKOUT 8**  
KS-SW-26



**STREET WORKOUT 9**  
KS-SW-27



**STREET WORKOUT 10**  
KS-SW-28



<b>STREET WORKOUT 5</b>	KS-SW-23	3,12 x 1,40 x 3,10	7,12 x 5,40	2,00
<b>STREET WORKOUT 6</b>	KS-SW-24	1,40 x 0,08 x 2,50	4,40 x 3,08	1,40
<b>STREET WORKOUT 7</b>	KS-SW-25	3,44 x 2,25 x 2,50	6,44 x 5,34	1,40
<b>STREET WORKOUT 8</b>	KS-SW-26	2,07 x 0,74 x 2,50	5,07 x 3,74	1,40
<b>STREET WORKOUT 9</b>	KS-SW-27	2,92 x 2,92 x 2,50	6,92 x 6,92	1,40
<b>STREET WORKOUT 10</b>	KS-SW-28	2,72 x 2,82 x 2,50	6,72 x 6,82	1,40
<b>STREET WORKOUT 11</b>	KS-SW-29	3,74 x 2,30 x 2,50	6,74 x 5,30	1,40



**STREET WORKOUT 11**  
KS-SW-29





**STREET WORKOUT 14**  
KS-SW-32



**STREET WORKOUT 15**  
KS-SW-33



**STREET WORKOUT 16**  
KS-SW-34



**STREET WORKOUT 12**  
KS-SW-30



**STREET WORKOUT 13**  
KS-SW-31



**STREET WORKOUT 17**  
KS-SW-42



<b>STREET WORKOUT 14</b>	KS-SW-32	4,04 x 0,08 x 2,50	7,04 x 3,08	1,40
<b>STREET WORKOUT 15</b>	KS-SW-33	4,84 x 0,08 x 3,10	8,84 x 4,08	2,00
<b>STREET WORKOUT 16</b>	KS-SW-34	4,05 x 0,08 x 2,50	7,05 x 3,08	1,40
<b>STREET WORKOUT 12</b>	KS-SW-30	4,00 x 3,20 x 2,50	7,00 x 6,20	1,40
<b>STREET WORKOUT 13</b>	KS-SW-31	6,32 x 1,00 x 2,50	9,32 x 4,00	1,40
<b>STREET WORKOUT 17</b>	KS-SW-42	2,32 x 2,16 x 2,50	5,32 x 5,16	1,40





**STREET WORKOUT 18**  
KS-SW-44



**STREET WORKOUT 19**  
KS-SW-45



**STREET WORKOUT 20**  
KS-SW-46



**STREET WORKOUT 21**  
KS-SW-47

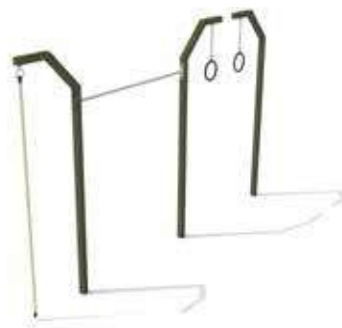

**STREET WORKOUT 22**  
KS-SW-48



**STREET WORKOUT 23**  
KS-SW-49



<b>STREET WORKOUT 18</b>	KS-SW-44	4,24 x 1,00 x 2,50	7,24 x 4,00	1,40
<b>STREET WORKOUT 19</b>	KS-SW-45	5,56 x 1,40 x 2,50	8,56 x 4,40	1,40
<b>STREET WOKROUT 20</b>	KS-SW-46	11,32 x 4,62 x 3,10	15,32 x 8,62	2,00
<b>STREET WORKOUT 21</b>	KS-SW-47	6,34 x 0,08	10,34 x 4,08	1,40
<b>STREET WORKOUT 22</b>	KS-SW-48	5,08 x 0,08	9,08 x 4,08	1,50
<b>STREET WORKOUT 23</b>	KS-SW-49	4,00 x 4,25	8,00 x 4,25	1,25
<b>STREET WORKOUT 24</b>	KS-SW-50	4,50 x 2,27	8,50 x 6,27	1,40
<b>STREET WORKOUT 25</b>	KS-SW-51	4,25 x 2,90	8,25 x 6,90	1,40
<b>STREET WORKOUT 26</b>	KS-SW-52	5,33 x 3,82	9,33 x 7,82	1,40



**STREET WORKOUT 24**  
KS-SW-50



**STREET WORKOUT 25**  
KS-SW-51



**STREET WORKOUT 26**  
KS-SW-52





**STREET WORKOUT 27**  
KS-SW-53



**STREET WORKOUT 28**  
KS-SW-54



**STREET WORKOUT 29**  
KS-SW-55



**HORIZONTAL LADDER 2**  
**BRÜCKE 2**  
KS-SW-11



**HORIZONTAL LADDER 1**  
**BRÜCKE 1**  
KS-SW-10



**PUNCHING BAG**  
**BOXSACK**  
KS-SW-04



<b>STREET WORKOUT 27</b>	KS-SW-53	7,26 x 4,25	11,26 x 8,25	1,40
<b>STREET WORKOUT 28</b>	KS-SW-54	7,26 x 6,68	11,26 x 10,68	1,40
<b>STREET WORKOUT 29</b>	KS-SW-55	8,77 x 7,26	12,77 x 11,26	1,40
<b>HORIZONTAL LADDER 2</b>	KS-SW-11	2,16 x 1,00 x 2,50	5,16 x 4,00	1,40
<b>HORIZONTAL LADDER 1</b>	KS-SW-10	2,16 x 1,00 x 2,50	5,16 x 4,00	1,40
<b>PUNCHING BAG</b>	KS-SW-04	1,50 x 0,35 x 2,50	4,50 x 3,35	-
<b>HORIZONTAL BAR WITH HANDLES</b>	KS-SW-06	2,16 x 0,31 x 2,50	6,16 x 4,31	1,50
<b>GYMNASTIC RINGS</b>	KS-SW-07	1,80 x 0,21 x 2,60	5,80 x 4,21	1,50
<b>PULL UP ROPE</b>	KS-SW-02	1,80 x 0,08 x 3,10	5,80 x 4,10	2,00
<b>HORIZONTAL BAR</b>	KS-SW-05	1,60 x 0,08 x 2,50	4,60 x 3,08	1,40



**HORIZONTAL BAR  
WITH HANDLES**  
CALISTHENICS  
HANGELBRÜCKE  
KS-SW-06



**GYMNASTIC  
RINGS**  
CALISTHENICS  
RINGE  
KS-SW-07







**PULL UP ROPE**  
OUTDOOR  
WORKOUT  
KLETTERSEIL  
KS-SW-02

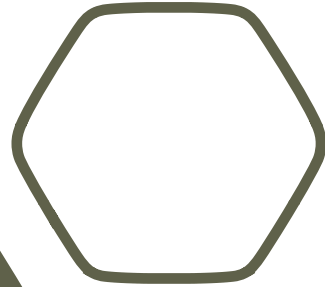

**HORIZONTAL  
BAR**  
CALISTHENICS  
TURNRECK  
KS-SW-05





	...			
<b>VERTICAL LADDER 3</b>	KS-SW-36	1,40 x 0,80 x 3,10	4,40 x 4,80	2,00
<b>VERTICAL LADDER 2</b>	KS-SW-09	1,40 x 0,08 x 2,50	5,40 x 4,08	1,40
<b>VERTICAL LADDER 1</b>	KS-SW-08	1,40 x 0,08 x 2,50	4,40 x 3,08	1,40
<b>PULL UP PIPE</b>	KS-SW-03	0,94 x 0,08 x 2,50	3,94 x 3,08	1,40
<b>UP-DOWN BENCH 1</b>	KS-SW-40	1,48 x 0,40 x 1,40	3,61 x 2,46	1,40
<b>UP-DOWN BENCH 2</b>	KS-SW-41	2,86 x 0,40 x 1,40	4,92 x 2,46	1,40
<b>BRIDGE</b>	KS-SW-17	2,16 x 1,00 x 1,40	5,16 x 4,00	0,30
<b>SLALOM</b>	KS-SW-18	2,16 x 1,00 x 1,40	5,16 x 4,00	0,30
<b>BALANCE BEAM</b>	KS-SW-39	2,51 x 0,08 x 0,26	5,51 x 3,08	0,26
<b>BALANCE PATH</b>	KS-SW-37	2,31 x 1,06 x 0,2	5,31 x 4,06	0,20
<b>CLIMBING STEPS</b>	KS-SW-38	0,61 x 0,59 x 2,23	3,61 x 3,59	0,61



**VERTICAL  
LADDER 3  
CALISTHENICS  
LEITER MIT  
AUSLEGER**  
KS-SW-36



**VERTICAL  
LADDER 2  
CALISTHENICS  
LEITER 2**  
KS-SW-09



**VERTICAL  
LADDER 1  
CALISTHENICS  
LEITER 1**  
KS-SW-08



**PULL UP PIPE  
STREET  
WORKOUT  
FEUERWEHR-  
STANGE**  
KS-SW-03



**UP-DOWN  
BENCH 1  
SIT-UPS  
BANK 1**  
KS-SW-40



**UP-DOWN  
BENCH 2  
SIT-UPS BANK 2**  
KS-SW-41



**BRIDGE  
BRÜCKE**  
KS-SW-17



**SLALOM  
SLALOM BRÜCKE**  
KS-SW-18



**BALANCE BEAM  
BALANCIERBALKEN**  
KS-SW-39



**BALANCE PATH  
BALANCIERPFAD**  
KS-SW-37



**CLIMBING STEPS  
KLETTERSTUFEN**  
KS-SW-38



**TWO TRIANGULAR HANDLES**  
ZWEI DREIECKIGE GRIFFE  
KS-SW-14a



**LARGE SQUARE HANDLE**  
TURNRECK SEITENGRIF  
KS-SW-12



**SMALL SQUARE HANDLE**  
TURNRECK KLEINER GRIF  
KS-SW-13



**TRIANGULAR HANDLE**  
DREIECK GRIF  
KS-SW-14



**GYMNASTIC RAILS 1**  
DIP BARREN 1  
KS-SW-16



**GYMNASTIC RAILS 2**  
DIP BARREN 2  
KS-SW-35



**GYMNASTIC RAILS WITH POSTS**  
DIP STATION  
KS-SW-15



<b>TWO TRIANGULAR HANDLES</b>	KS-SW-14a	0,73 x 0,68 x 2,50	3,73 x 3,68	0,20
<b>LARGE SQUARE HANDLE</b>	KS-SW-12	0,73 x 0,08 x 2,50	4,73 x 4,10	1,20
<b>SMALL SQUARE HANDLE</b>	KS-SW-13	0,28 x 0,08 x 2,50	3,28 x 3,08	0,40
<b>TRIANGULAR HANDLE</b>	KS-SW-14	0,73 x 0,08 x 2,50	3,73 x 3,08	0,20
<b>GYMNASTIC RAILS 1</b>	KS-SW-16	1,30 x 0,58 x 1,20	4,30 x 3,58	0,20
<b>GYMNASTIC RAILS 2</b>	KS-SW-35	1,30 x 0,58 x 0,20	4,30 x 3,58	0,20
<b>GYMNASTIC RAILS WITH POSTS</b>	KS-SW-15	1,60 x 0,6 x 1,70	4,60 x 3,60	0,20





**NINJA PARK 1**  
KS-NP-001







**NINJA PARK 2**  
KS-NP-002



**NINJA PARK 3**  
KS-NP-003



**NINJA PARK 4**  
KS-NP-004

	...			
<b>NINJA PARK 1</b>	KS-NP-001	3,37 x 1,66 x 2,70	7,37 x 5,66	1,43
<b>NINJA PARK 2</b>	KS-NP-002	3,37 x 1,66 x 2,70	7,37 x 5,66	1,17
<b>NINJA PARK 3</b>	KS-NP-003	3,37 x 1,66 x 2,96	7,37 x 5,66	1,36
<b>NINJA PARK 4</b>	KS-NP-004	3,37 x 1,66 x 2,70	7,37 x 5,66	1,62
<b>NINJA PARK 5</b>	KS-NP-005	3,37 x 1,66 x 2,70	7,37 x 5,66	0,78
<b>NINJA PARK 6</b>	KS-NP-006	3,37 x 1,66 x 2,70	7,37 x 5,66	1,35
<b>START&amp;STOP</b>	IS-TA-114	9,96 x 3,32 x 2,96	13,96 x 7,32	1,62



**NINJA PARK 5**  
KS-NP-005



**NINJA PARK 6**  
KS-NP-006



**NINJA PARK SET 1**  
KS-NP-101



**START&STOP**  
IS-TA-114



# *ARENAS*





**SOCCER RING 3**



**SOCCER RING 2**

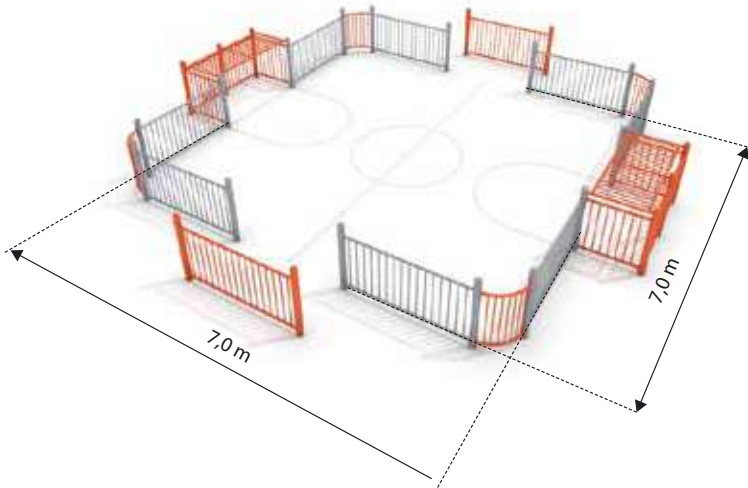

**ARENA 1A**

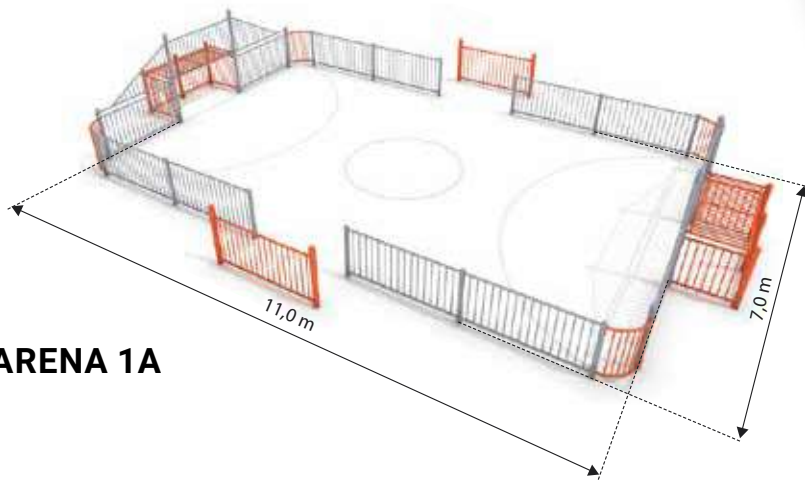

**ARENA 1**



**ARENA 2A**

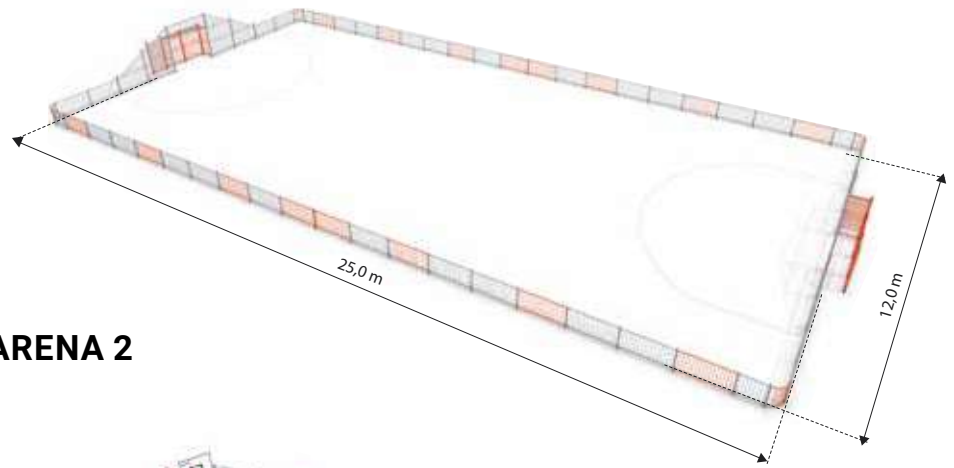

**ARENA 2**

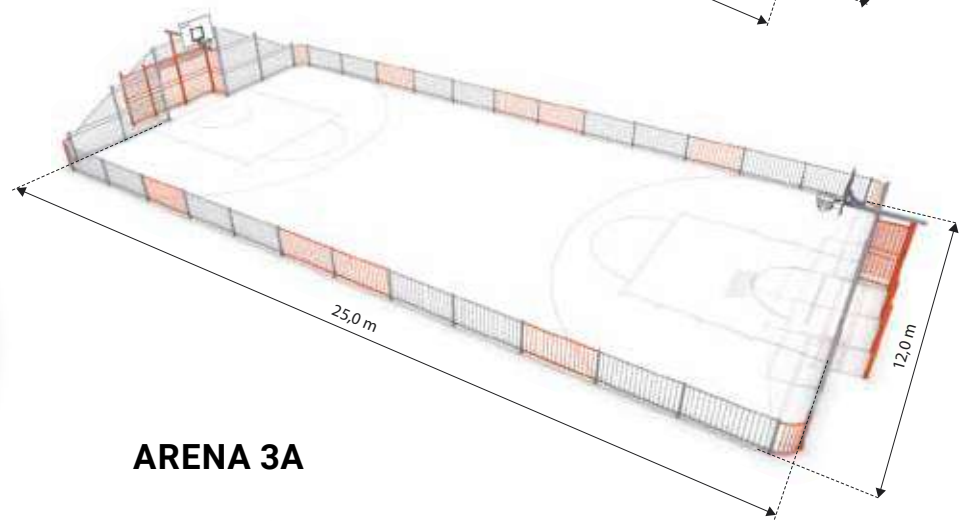

**ARENA 3A**

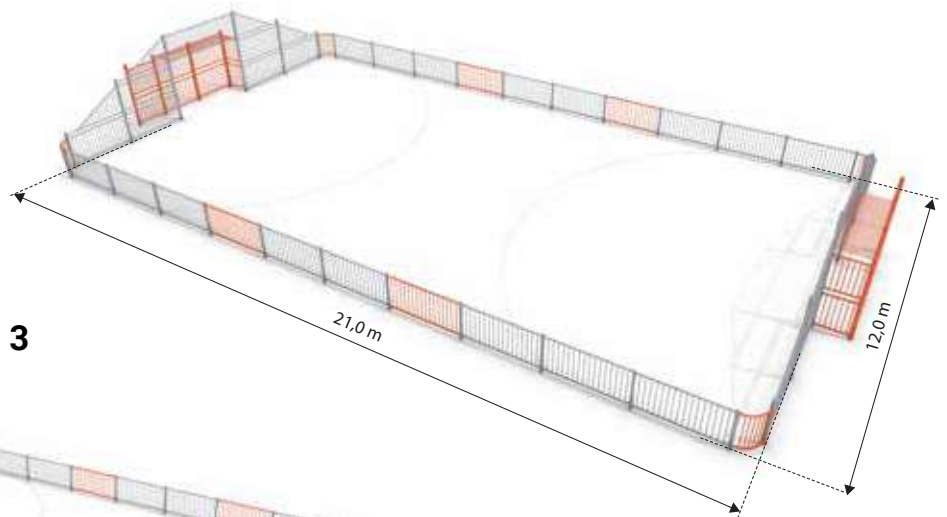

**ARENA 3**

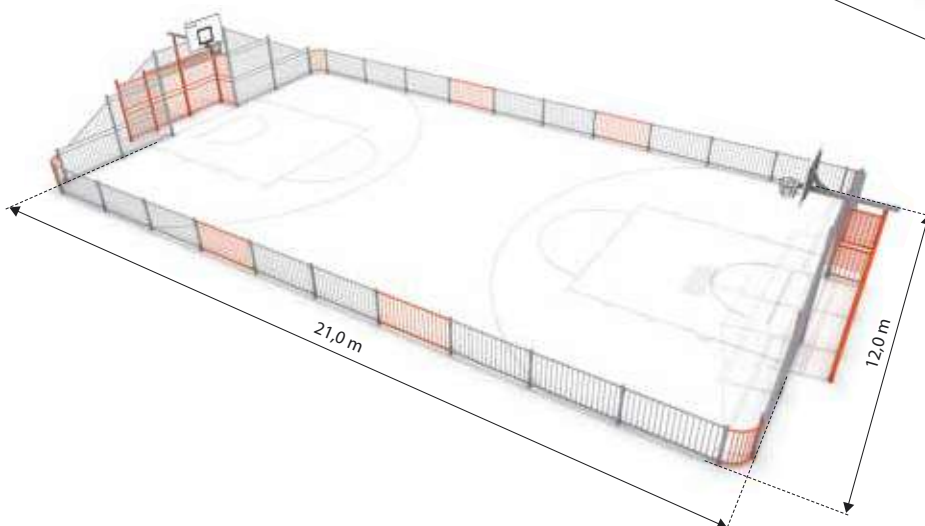

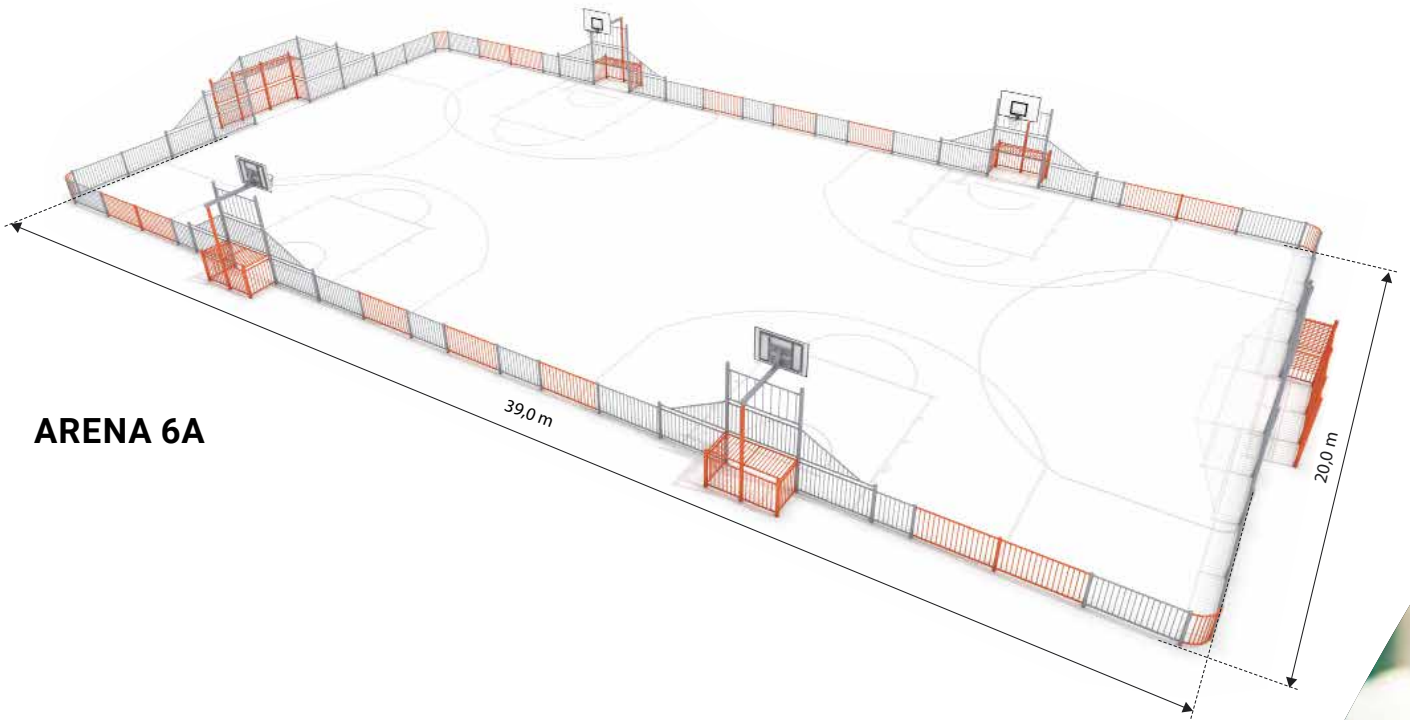

**ARENA 6A**



**FOOTBALL GOAL 1**

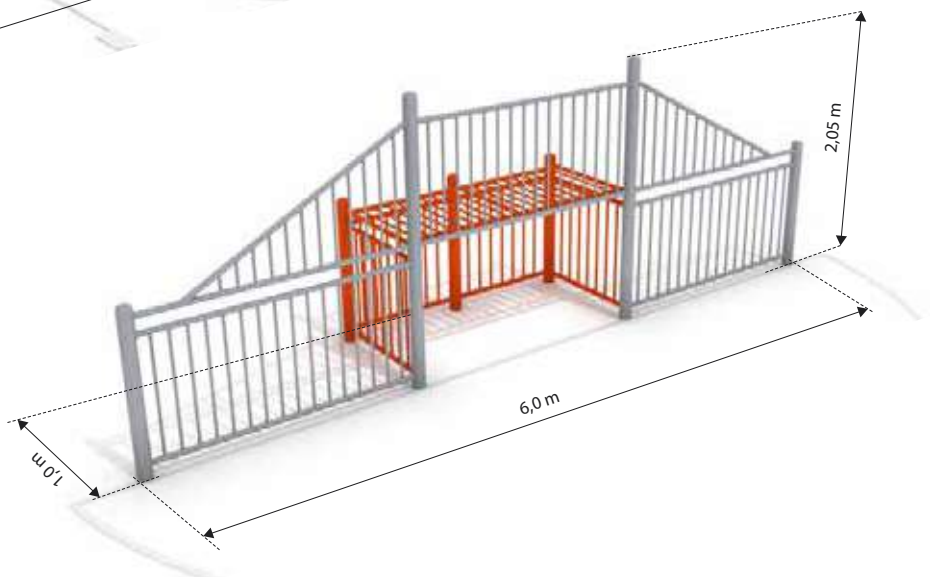

**FOOTBALL GOAL 3**





# OUTDOOR GAMES

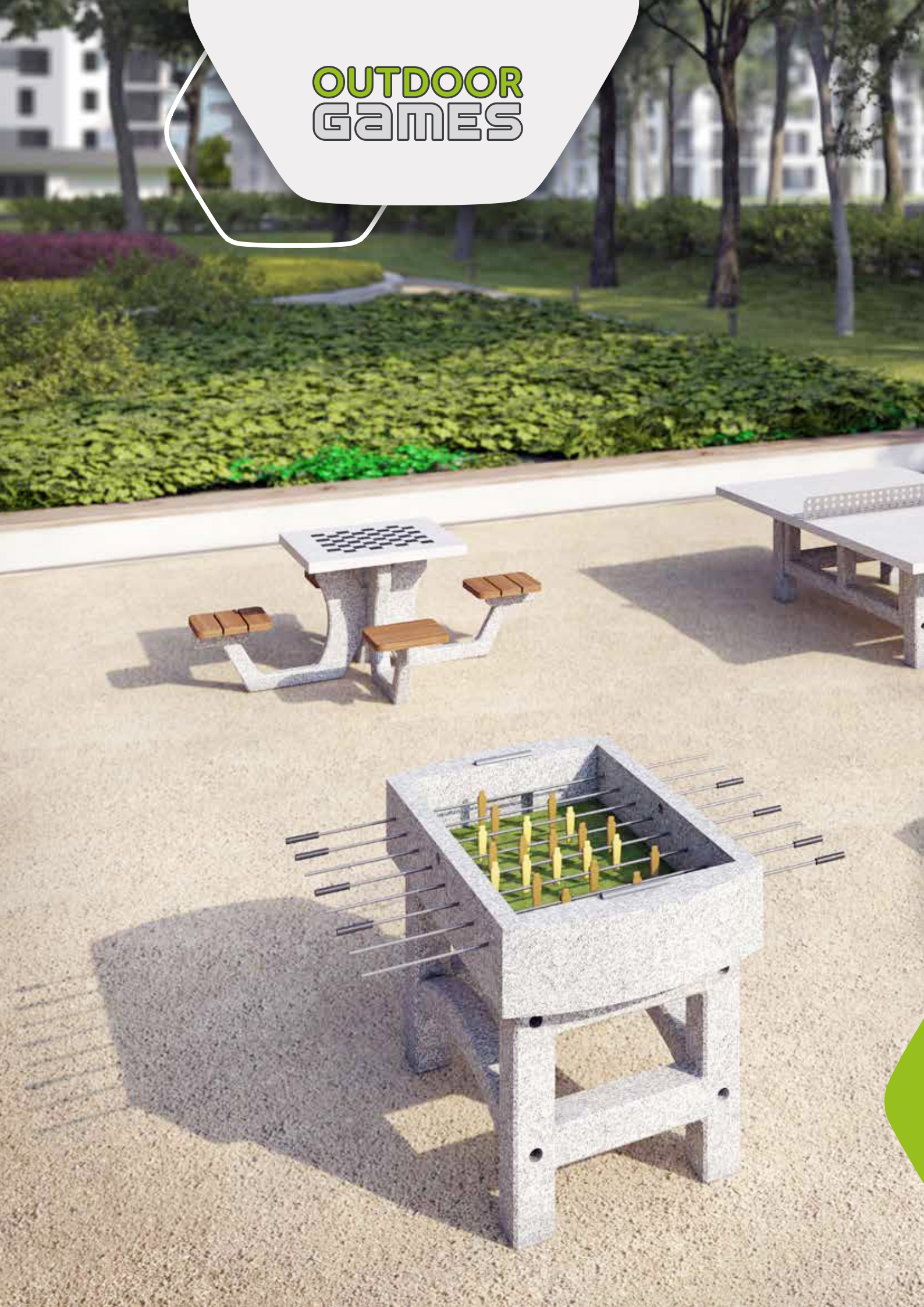





**TENNIS TABLE 01/02**  
**TISCHTENNISPLATTE 01/02**  
KT-02-CR-007/008

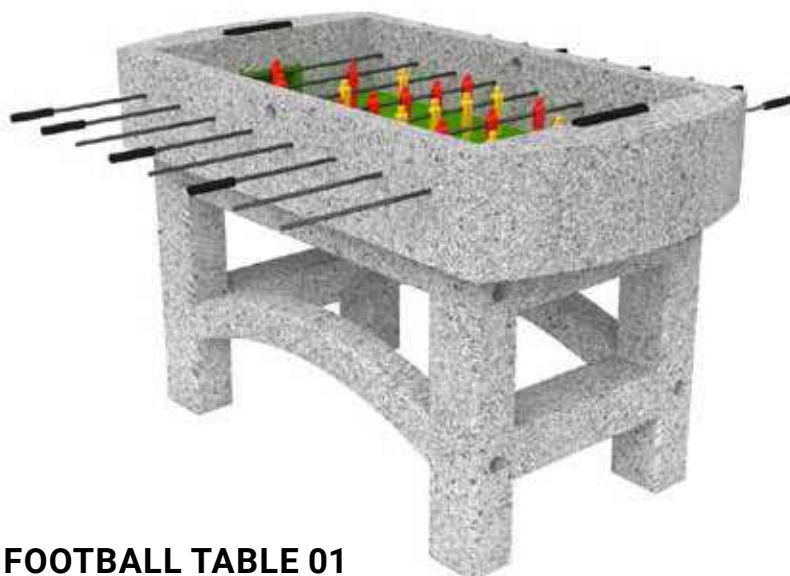

**FOOTBALL TABLE 01**  
**KICKERTISCH 01**  
KT-02-CR-009



**TENNIS TABLE 01/02**

KT-02-CR-007/008

2,74 x 1,52 x 0,78

**FOOTBALL TABLE 01**

KT-02-CR-009

1,52 x 0,80 x 0,88

**TABLE FOR CHESS - CHECKERS 01**

KT-02-CR-001

2,00 x 2,00 x 0,81

**PICNIC TABLE 01**

KT-02-CR-011

2,00 x 2,00 x 0,81

**PICNIC TABLE 02**

KT-02-CR-012

2,00 x 2,00 x 0,78

**Concrete games tables | Spieltische aus Beton**



**TABLE FOR CHESS -  
CHECKERS 01**  
KT-02-CR-001



**TABLE FOR LUDO GAME 01**  
KT-02-CR-002



**PICNIC TABLE 01**  
KT-02-CR-011



**PICNIC TABLE 02**  
KT-02-CR-012



**TABLE FOR CHESS - CHECKERS 03**

T-02-CR-005

**PICNIC TABLE 03**

KT-02-CR-013

**TABLE FOR LUDO GAME 03**

KT-02-CR-006



<b>TABLE FOR CHESS - CHECKERS 03</b>	KT-02-CR-005	2,00 x 2,00 x 0,83	-
<b>PICNIC TABLE 03</b>	KT-02-CR-013	2,00 x 2,00 x 0,83	-
<b>TABLE FOR LUDO GAME 03</b>	KT-02-CR-006	2,00 x 2,00 x 0,83	-
<b>TABLE FOR CHESS - CHECKERS / LUDO GAME</b>	KT-02-CR-010	2,00 x 2,00 x 0,78	-
<b>TABLE FOR CHESS - CHECKERS 02</b>	KT-02-CR-003	2,00 x 2,00 x 0,78	-
<b>TABLE FOR LUDO GAME 02</b>	KT-02-CR-004	2,00 x 2,00 x 0,78	-



**TABLE FOR CHESS -  
CHECKERS / LUDO GAME 02**  
KT-02-CR-010



**TABLE FOR CHESS - CHECKERS 02**  
KT-02-CR-003



**TABLE FOR LUDO GAME 02**  
KT-02-CR-004

# URBAN FURNITURE





**TOPAZO**



**BENCH 3**



**BENCH 2**



**BENCH 4**



**BENCH 1**



**BENCH 11**



**BENCH 5**



**BENCH 7**



**TRASH BIN 5**



ARMITA



BENCH 9

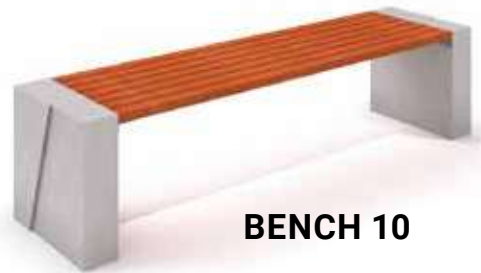

BENCH 10



TABLE 2



TRASH BIN 1



**KRETO**

---



**BENCH 5**



**BENCH 6**



**TRASH BIN 7**

**PERLO**

---

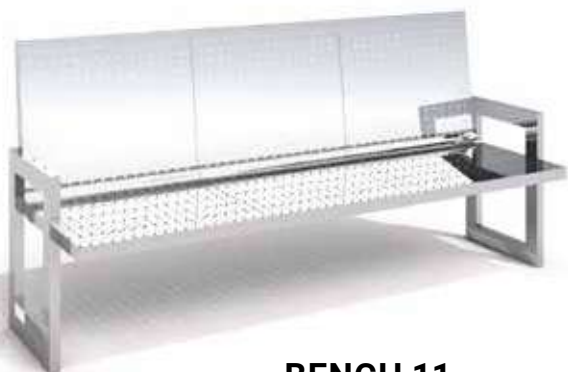

**BENCH 11**

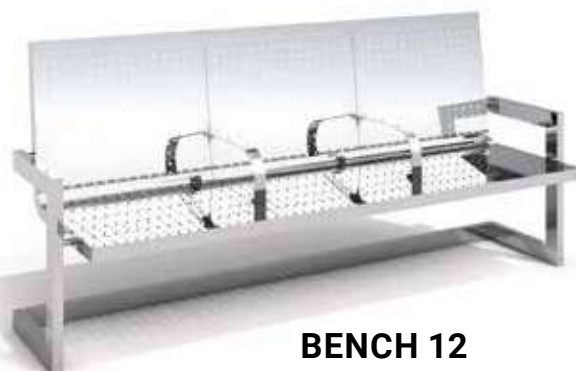

**BENCH 12**



**BICYCLE RACK 24**



**TRASH BIN 6**

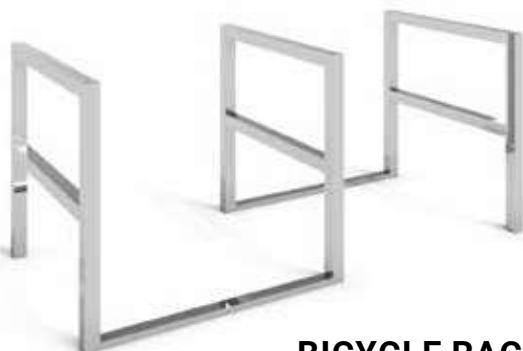

**BICYCLE RACK 6**



**TRASH BIN 7**

**MALAKITO**



**BENCH 19**



**BENCH 20**



**TRASH BIN 4**



## JAGO

---



BENCH 16

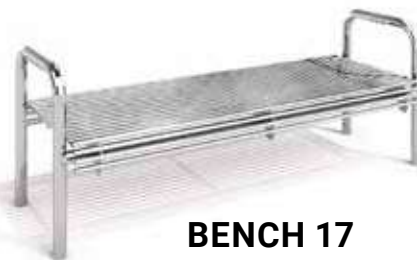

BENCH 17

TRASH BIN 7



TRASH BIN 5



TRASH BIN 6



BICYCLE RACK 8



BICYCLE RACK 10



BICYCLE RACK 26

## SAFIRO

---



BENCH 5



BENCH 6



BENCH 7



TRASH BIN 1



TRASH BIN 2

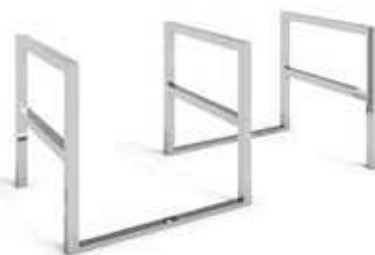

BICYCLE RACK 6

**KRONO**

---



**BENCH 21**



**BENCH 15**



**BENCH 3**



**BICYCLE RACK 2**



**BICYCLE RACK 8**



**BICYCLE RACK 1**



Benches made of Deco concrete | Sitzbänke aus Dekobeton



DECO CONCRETE BENCH 1



DECO CONCRETE BENCH 2



DECO CONCRETE BENCH 3



DECO CONCRETE BENCH 4



DECO CONCRETE BENCH 5



DECO CONCRETE BENCH 6



DECO CONCRETE BENCH 7



DECO CONCRETE BENCH 8



DECO CONCRETE BENCH 9



DECO CONCRETE BENCH 10



DECO CONCRETE BENCH 11



DECO CONCRETE BENCH 12



DECO CONCRETE BENCH 13



DECO CONCRETE BENCH 14

Concrete benches | Sitzbänke aus gewaschenem Beton



CONCRETE BENCH 1



CONCRETE BENCH 2



CONCRETE BENCH 5



CONCRETE BENCH 6



CONCRETE BENCH 7



CONCRETE BENCH 8



CONCRETE BENCH 9



CONCRETE BENCH 3



CONCRETE PLANTER SET WITH BENCH 1



CONCRETE PLANTER SET WITH BENCH 2



CONCRETE PLANTER SET WITH BENCH 3



CONCRETE BENCH 4



CONCRETE PLANTER SET WITH BENCH 1



CONCRETE PLANTER SET WITH BENCH 2



CONCRETE PLANTER SET WITH BENCH 3

**Stainless steel and steel benches | Edelstahl Sitzbänke**



**STAINLESS STEEL BENCH 1**



**STAINLESS STEEL BENCH 2**



**STAINLESS STEEL BENCH 3**



**STAINLESS STEEL BENCH 4**



**STAINLESS STEEL BENCH 5**



**STAINLESS STEEL BENCH 6**



**STAINLESS STEEL BENCH 7**



**STAINLESS STEEL BENCH 8**



**STAINLESS STEEL BENCH 9**



**STAINLESS STEEL BENCH 10**



**STAINLESS STEEL BENCH 11**



**STAINLESS STEEL BENCH 12**



**STAINLESS STEEL BENCH 13**



**STAINLESS STEEL BENCH 14**



**STAINLESS STEEL BENCH 15**



**STAINLESS STEEL BENCH 16**



**STAINLESS STEEL BENCH 17**



**STAINLESS STEEL BENCH 18**



**STAINLESS STEEL BENCH 19**



**STAINLESS STEEL BENCH 20**



**STAINLESS STEEL BENCH 21**



Decorative trash bins made of Deco concrete | Mülleimer aus Dekobeton



DECO WHITE CONCRETE TRASH BIN 1



DECO WHITE CONCRETE TRASH BIN 2

Concrete trash bins | Mülleimer aus gewaschenem Beton



CONCRETE TRASH BIN 1



CONCRETE TRASH BIN 2



CONCRETE TRASH BIN 3



CONCRETE TRASH BIN 4



CONCRETE TRASH BIN 5



CONCRETE TRASH BIN 6



CONCRETE TRASH BIN 7

Stainless steel and steel trash bins | Edelstahl Mülleimer



STAINLESS STEEL TRASH BIN 8



STAINLESS STEEL TRASH BIN 1



STAINLESS STEEL TRASH BIN 2



STAINLESS STEEL TRASH BIN 3



STAINLESS STEEL TRASH BIN 4



STAINLESS STEEL TRASH BIN 5



STAINLESS STEEL TRASH BIN 6



STAINLESS STEEL TRASH BIN 7



Stainless steel and steel bicycle racks | Edelstahl Fahrradständer



**STAINLESS STEEL  
BICYCLE RACK 1**



**STAINLESS STEEL  
BICYCLE RACK 2**



**STAINLESS STEEL  
BICYCLE RACK 4**



**STAINLESS STEEL  
BICYCLE RACK 5**



**STAINLESS STEEL  
BICYCLE RACK 6**



**STAINLESS STEEL  
BICYCLE RACK 7**



**STAINLESS STEEL  
BICYCLE RACK 8**



**STAINLESS STEEL  
BICYCLE RACK 10**



**STAINLESS STEEL  
BICYCLE RACK 11**



**STAINLESS STEEL  
BICYCLE RACK 12**



**STAINLESS STEEL  
BICYCLE RACK 13**



**STAINLESS STEEL  
BICYCLE RACK 14**

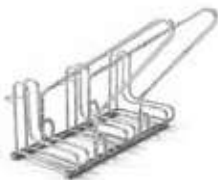

**STAINLESS STEEL  
BICYCLE RACK 15**



**STAINLESS STEEL  
BICYCLE RACK 16**



**STAINLESS STEEL  
BICYCLE RACK 17**



**STAINLESS STEEL  
BICYCLE RACK 18**

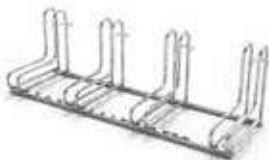

**STAINLESS STEEL  
BICYCLE RACK 19**



**STAINLESS STEEL  
BICYCLE RACK 20**

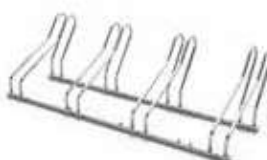

**STAINLESS STEEL  
BICYCLE RACK 21**



**STAINLESS STEEL  
BICYCLE RACK 22**



**STAINLESS STEEL  
BICYCLE RACK 24**



**STAINLESS STEEL  
BICYCLE RACK 25**



**STAINLESS STEEL  
BICYCLE RACK 26**



### Export

+48 91 50 65 041  
export@inter-play.eu  
www.inter-play.eu

### Deutschland / Österreich

+ 49 (0) 160 9964 9941  
info@interplay-spiel.de  
www.interplay-spiel.de



European Funds  
for Smart Economy



Republic  
of Poland

Co-funded by the  
European Union

